

Lecture 22

Tue. 11.08.2016

Introduction to Spinor-Vector resonance dynamics

(Ch. 2-4 of Unit 4 Ch. 6-7 of Unit 6)

Review: 2D harmonic oscillator equations with Lagrangian and matrix forms

ANALOGY: 2-State Schrodinger: $i\hbar\partial_t|\Psi(t)\rangle = \mathbf{H}|\Psi(t)\rangle$ versus Classical 2D-HO: $\partial_t^2\mathbf{x} = -\mathbf{K}\cdot\mathbf{x}$

Hamilton-Pauli spinor symmetry (σ -expansion in ABCD-Types) $\mathbf{H} = \omega_\mu \sigma_\mu$

Derive σ -exponential time evolution (or revolution) operator $\mathbf{U} = e^{-i\mathbf{H}t} = e^{-i\sigma_\mu \omega_\mu t}$

Spinor arithmetic like complex arithmetic

Spinor vector algebra like complex vector algebra

Spinor exponentials like complex exponentials (“Crazy-Thing”-Theorem)

Geometry of evolution (or revolution) operator $\mathbf{U} = e^{-i\mathbf{H}t} = e^{-i\sigma_\mu \omega_\mu t}$

The “mysterious” factors of 2 (or 1/2): 2D Spinor vs 3D Spin Vector space

2D Spinor vs 3D vector rotation

NMR Hamiltonian: 3D Spin Moment \mathbf{m} in \mathbf{B} field

Euler’s state definition using rotations $\mathbf{R}(\alpha, 0, 0)$, $\mathbf{R}(0, \beta, 0)$, and $\mathbf{R}(0, 0, \gamma)$

Spin-1 (3D-real vector) case

Spin-1/2 (2D-complex spinor) case

3D-real Stokes Vector defines 2D-HO polarization ellipses and spinor states

Asymmetry $S_A = S_Z$, Balance $S_B = S_X$, and Chirality $S_C = S_Y$

Polarization ellipse and spinor state dynamics

The “Great Spectral Avoided-Crossing” and A-to-B-to-A symmetry breaking

See also:
QTCA
Lect. 9(2.12)
p.61-103 for
polarization
ellipsometry

2D harmonic oscillator equations

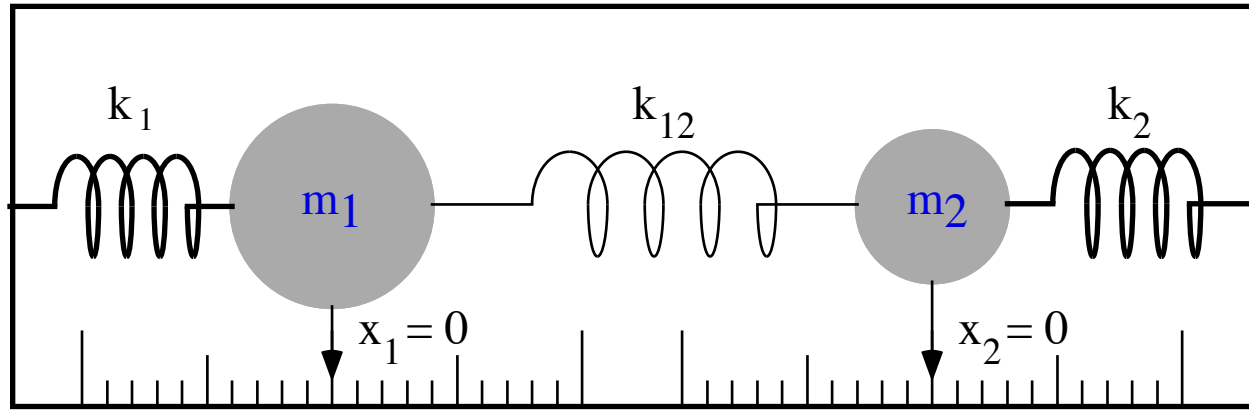

Fig. 3.3.1 Two 1-dimensional coupled oscillators

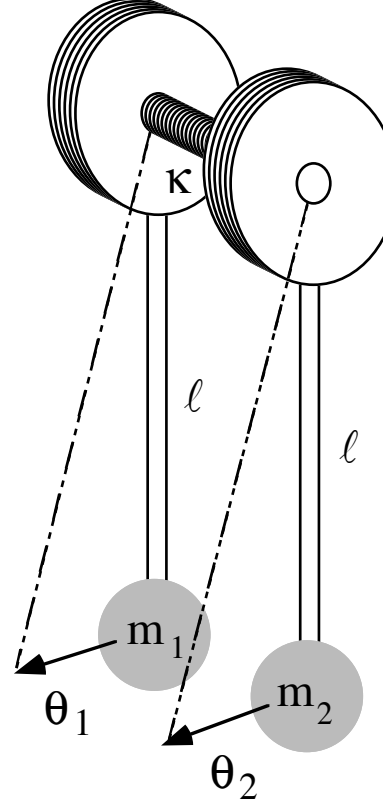
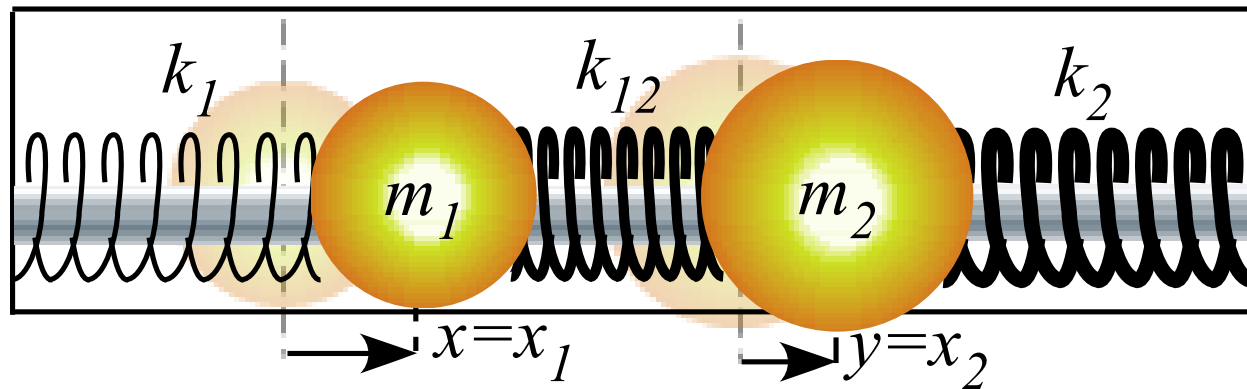

Fig. 3.3.2 Coupled pendulums

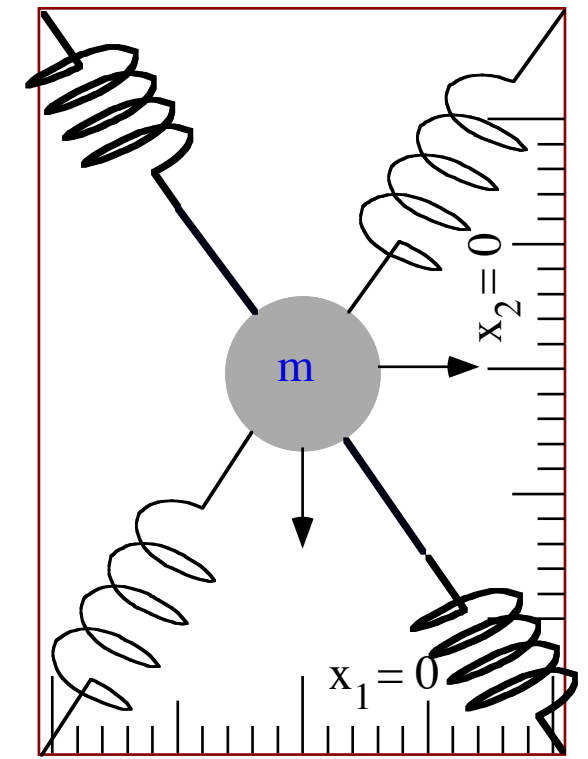

Fig. 3.3.3 One 2-dimensional coupled oscillator

(Review of Lect. 21)

2D HO kinetic energy $T(v_1, v_2)$

$$T = \frac{1}{2} m_1 \dot{x}_1^2 + \frac{1}{2} m_2 \dot{x}_2^2$$

$$= \frac{1}{2} \langle \dot{\mathbf{x}} | \mathbf{M} | \dot{\mathbf{x}} \rangle$$

2D HO potential energy $V(x_1, x_2)$

$$V = \frac{1}{2} (k_1 + k_{12}) x_1^2 - k_{12} x_1 x_2 + \frac{1}{2} (k_2 + k_{12}) x_2^2$$

$$= \frac{1}{2} \langle \mathbf{x} | \mathbf{K} | \mathbf{x} \rangle$$

where: $\mathbf{K} = \begin{pmatrix} k_1 + k_{12} & -k_{12} \\ -k_{12} & k_2 + k_{12} \end{pmatrix}$

Lagrangian $L=T-V$

2D HO Lagrange equations

$$\frac{d}{dt} \left(\frac{\partial T}{\partial \dot{x}_1} \right) = m_1 \ddot{x}_1 = F_1 = -\frac{\partial V}{\partial x_1} = -(k_1 + k_{12}) x_1 + k_{12} x_2$$

$$\frac{d}{dt} \left(\frac{\partial T}{\partial \dot{x}_2} \right) = m_2 \ddot{x}_2 = F_2 = -\frac{\partial V}{\partial x_2} = k_{12} x_1 - (k_2 + k_{12}) x_2$$

2D HO Matrix operator equations

$$\begin{pmatrix} m_1 & 0 \\ 0 & m_2 \end{pmatrix} \begin{pmatrix} \ddot{x}_1 \\ \ddot{x}_2 \end{pmatrix} = - \begin{pmatrix} k_1 + k_{12} & -k_{12} \\ -k_{12} & k_2 + k_{12} \end{pmatrix} \begin{pmatrix} x_1 \\ x_2 \end{pmatrix}$$

Matrix operator notation:

$$\mathbf{M} \cdot | \ddot{\mathbf{x}} \rangle = - \mathbf{K} \cdot | \mathbf{x} \rangle$$

2D harmonic oscillator equation solutions (Review of Lect. 21)

1. May rewrite equation $\mathbf{M} \cdot |\ddot{\mathbf{x}}\rangle = -\mathbf{K} \cdot |\mathbf{x}\rangle$ in acceleration matrix form: $|\ddot{\mathbf{x}}\rangle = -\mathbf{A}|\mathbf{x}\rangle$ where: $\mathbf{A} = \mathbf{M}^{-1} \cdot \mathbf{K}$

$$\begin{pmatrix} \ddot{x}_1 \\ \ddot{x}_2 \end{pmatrix} = - \begin{pmatrix} m_1 & 0 \\ 0 & m_2 \end{pmatrix}^{-1} \begin{pmatrix} k_1 + k_{12} & -k_{12} \\ -k_{12} & k_2 + k_{12} \end{pmatrix} \begin{pmatrix} x_1 \\ x_2 \end{pmatrix} = - \begin{pmatrix} \frac{k_1 + k_{12}}{m_1} & \frac{-k_{12}}{m_1} \\ \frac{-k_{12}}{m_2} & \frac{k_2 + k_{12}}{m_2} \end{pmatrix} \begin{pmatrix} x_1 \\ x_2 \end{pmatrix}$$

2. Need to find *eigenvectors* $|\mathbf{e}_1\rangle, |\mathbf{e}_2\rangle, \dots$ of acceleration matrix such that: $\mathbf{A}|\mathbf{e}_n\rangle = \varepsilon_n|\mathbf{e}_n\rangle = \omega_n^2|\mathbf{e}_n\rangle$

Then equations decouple to: $|\ddot{\mathbf{e}}_n\rangle = -\mathbf{A}|\mathbf{e}_n\rangle = -\varepsilon_n|\mathbf{e}_n\rangle = -\omega_n^2|\mathbf{e}_n\rangle$ where ε_n is an *eigenvalue*
and ω_n is an *eigenfrequency*

Note eigenvalue is square of eigenfrequency

To introduce eigensolutions we take a simple case of unit masses ($m_1=1=m_2$)

So equation of motion is simply: $|\ddot{\mathbf{x}}\rangle = -\mathbf{K}|\mathbf{x}\rangle$

Eigenvectors $|\mathbf{x}\rangle = |\mathbf{e}_n\rangle$ are in special directions where $|\ddot{\mathbf{x}}\rangle = -\mathbf{K}|\mathbf{x}\rangle$ is in same direction as $|\mathbf{x}\rangle$

➔ *ANALOGY: 2-State Schrodinger: $i\hbar\partial_t|\Psi(t)\rangle = \mathbf{H}|\Psi(t)\rangle$ versus Classical 2D-HO: $\partial_t^2\mathbf{x} = -\mathbf{K}\cdot\mathbf{x}$
 Hamilton-Pauli spinor symmetry (σ -expansion in *ABCD*-Types) $\mathbf{H} = \omega_\mu \sigma_\mu$*

Derive σ -exponential time evolution (or revolution) operator $\mathbf{U} = e^{-i\mathbf{H}t} = e^{-i\sigma_\mu \omega_\mu t}$

Spinor arithmetic like complex arithmetic

Spinor vector algebra like complex vector algebra

Spinor exponentials like complex exponentials (“Crazy-Thing”-Theorem)

Geometry of evolution (or revolution) operator $\mathbf{U} = e^{-i\mathbf{H}t} = e^{-i\sigma_\mu \omega_\mu t}$

The “mysterious” factors of 2 (or 1/2): 2D Spinor vs 3D Spin Vector space

2D Spinor vs 3D vector rotation

NMR Hamiltonian: 3D Spin Moment \mathbf{m} in \mathbf{B} field

ANALOGY: 2-State Schrodinger: $i\hbar\partial_t|\Psi(t)\rangle = \mathbf{H}|\Psi(t)\rangle$ versus Classical 2D-HO: $\partial_t^2\mathbf{x} = -\mathbf{K}\cdot\mathbf{x}$

(Review of Lect. 23)

$$i\hbar|\dot{\Psi}(t)\rangle = \mathbf{H}|\Psi(t)\rangle$$

$$|\ddot{\mathbf{x}}\rangle = -\mathbf{K}\cdot|\mathbf{x}\rangle$$

First start with 2-by-2 Hermitian (self-conjugate) matrix

$$\mathbf{H} = \begin{pmatrix} A & B-iC \\ B+iC & D \end{pmatrix} = \mathbf{H}^\dagger$$

H_{jk} matrix must
obey: $(H_{jk})^* = H_{kj}$

ANALOGY: 2-State Schrodinger: $i\hbar\partial_t|\Psi(t)\rangle = \mathbf{H}|\Psi(t)\rangle$ versus Classical 2D-HO: $\partial_t^2\mathbf{x} = -\mathbf{K}\cdot\mathbf{x}$

(Review of Lect. 23)

$$i\hbar|\dot{\Psi}(t)\rangle = \mathbf{H}|\Psi(t)\rangle$$

$$|\ddot{\mathbf{x}}\rangle = -\mathbf{K}\cdot|\mathbf{x}\rangle$$

First start with 2-by-2 Hermitian (self-conjugate) matrix

$$\mathbf{H} = \begin{pmatrix} A & B-iC \\ B+iC & D \end{pmatrix} = \mathbf{H}^\dagger$$

H_{jk} matrix must obey: $(H_{jk})^* = H_{kj}$

that operates on 2-D complex Dirac ket vector $|\Psi\rangle$.

*Both have 4 parameters
($2^2 = 2+2$)*

$$|\Psi\rangle = \begin{pmatrix} \Psi_1 \\ \Psi_2 \end{pmatrix} = \begin{pmatrix} x_1 + ip_1 \\ x_2 + ip_2 \end{pmatrix} = \begin{pmatrix} a_1 \\ a_2 \end{pmatrix}$$

ANALOGY: 2-State Schrodinger: $i\hbar\partial_t|\Psi(t)\rangle = \mathbf{H}|\Psi(t)\rangle$ versus Classical 2D-HO: $\partial_t^2\mathbf{x} = -\mathbf{K}\cdot\mathbf{x}$

(Review of Lect. 23)

$$i\hbar|\dot{\Psi}(t)\rangle = \mathbf{H}|\Psi(t)\rangle$$

$$|\ddot{\mathbf{x}}\rangle = -\mathbf{K}\cdot|\mathbf{x}\rangle$$

First start with 2-by-2 Hermitian (self-conjugate) matrix

$$\mathbf{H} = \begin{pmatrix} A & B - iC \\ B + iC & D \end{pmatrix} = \mathbf{H}^\dagger$$

H_{jk} matrix must obey: $(H_{jk})^* = H_{kj}$

that operates on 2-D complex Dirac ket vector $|\Psi\rangle$.

*Both have 4 parameters
($2^2 = 2+2$)*

$$|\Psi\rangle = \begin{pmatrix} \Psi_1 \\ \Psi_2 \end{pmatrix} = \begin{pmatrix} x_1 + ip_1 \\ x_2 + ip_2 \end{pmatrix} = \begin{pmatrix} a_1 \\ a_2 \end{pmatrix}$$

Separate real x_k and imaginary p_k parts of Ψ_k amplitudes to convert the complex 1st-order equation $i\partial_t\Psi = \mathbf{H}\Psi$ into pairs of real 1st-order differential equations.

ANALOGY: 2-State Schrodinger: $i\hbar\partial_t|\Psi(t)\rangle = \mathbf{H}|\Psi(t)\rangle$ versus Classical 2D-HO: $\partial_t^2\mathbf{x} = -\mathbf{K}\cdot\mathbf{x}$

(Review of Lect. 23)

$$i\hbar|\dot{\Psi}(t)\rangle = \mathbf{H}|\Psi(t)\rangle$$

$$|\ddot{\mathbf{x}}\rangle = -\mathbf{K}\cdot|\mathbf{x}\rangle$$

First start with 2-by-2 Hermitian (self-conjugate) matrix

$$\mathbf{H} = \begin{pmatrix} A & B-iC \\ B+iC & D \end{pmatrix} = \mathbf{H}^\dagger$$

H_{jk} matrix must obey: $(H_{jk})^* = H_{kj}$

that operates on 2-D complex Dirac ket vector $|\Psi\rangle$.

*Both have 4 parameters
($2^2 = 2+2$)*

$$|\Psi\rangle = \begin{pmatrix} \Psi_1 \\ \Psi_2 \end{pmatrix} = \begin{pmatrix} x_1 + ip_1 \\ x_2 + ip_2 \end{pmatrix} = \begin{pmatrix} a_1 \\ a_2 \end{pmatrix}$$

Separate real x_k and imaginary p_k parts of Ψ_k amplitudes to convert the complex 1st-order equation $i\partial_t\Psi = \mathbf{H}\Psi$ into pairs of real 1st-order differential equations.

$$i\hbar\frac{\partial}{\partial t}|\Psi(t)\rangle = \mathbf{H}|\Psi(t)\rangle$$

$$i\frac{\partial}{\partial t} \begin{pmatrix} x_1 + ip_1 \\ x_2 + ip_2 \end{pmatrix} = \begin{pmatrix} A & B-iC \\ B+iC & D \end{pmatrix} \begin{pmatrix} x_1 + ip_1 \\ x_2 + ip_2 \end{pmatrix}$$

ANALOGY: 2-State Schrodinger: $i\hbar\partial_t|\Psi(t)\rangle = \mathbf{H}|\Psi(t)\rangle$ versus Classical 2D-HO: $\partial_t^2\mathbf{x} = -\mathbf{K}\cdot\mathbf{x}$

(Review of Lect. 23)

$$i\hbar|\dot{\Psi}(t)\rangle = \mathbf{H}|\Psi(t)\rangle$$

$$|\ddot{\mathbf{x}}\rangle = -\mathbf{K}\cdot|\mathbf{x}\rangle$$

First start with 2-by-2 Hermitian (self-conjugate) matrix

$$\mathbf{H} = \begin{pmatrix} A & B-iC \\ B+iC & D \end{pmatrix} = \mathbf{H}^\dagger$$

H_{jk} matrix must obey: $(H_{jk})^* = H_{kj}$

that operates on 2-D complex Dirac ket vector $|\Psi\rangle$.

Both have 4 parameters
($2^2 = 2+2$)

$$|\Psi\rangle = \begin{pmatrix} \Psi_1 \\ \Psi_2 \end{pmatrix} = \begin{pmatrix} x_1 + ip_1 \\ x_2 + ip_2 \end{pmatrix} = \begin{pmatrix} a_1 \\ a_2 \end{pmatrix}$$

Separate real x_k and imaginary p_k parts of Ψ_k amplitudes to convert the complex 1st-order equation $i\partial_t\Psi = \mathbf{H}\Psi$ into pairs of real 1st-order differential equations.

$$\begin{aligned} \dot{x}_1 &= Ap_1 + Bp_2 - Cx_2 & \dot{p}_1 &= -Ax_1 - Bx_2 - Cp_2 \\ \dot{x}_2 &= Bp_1 + Dp_2 + Cx_1 & \dot{p}_2 &= -Bx_1 - Dx_2 + Cp_1 \end{aligned}$$

$$i\hbar\frac{\partial}{\partial t}|\Psi(t)\rangle = \mathbf{H}|\Psi(t)\rangle$$

$$i\frac{\partial}{\partial t} \begin{pmatrix} x_1 + ip_1 \\ x_2 + ip_2 \end{pmatrix} = \begin{pmatrix} A & B-iC \\ B+iC & D \end{pmatrix} \begin{pmatrix} x_1 + ip_1 \\ x_2 + ip_2 \end{pmatrix}$$

$$\begin{pmatrix} i\dot{x}_1 - \dot{p}_1 \\ i\dot{x}_2 - \dot{p}_2 \end{pmatrix} = \begin{pmatrix} Ax_1 + Bx_2 + Cp_2 + iAp_1 + iBp_2 - iCx_2 \\ Bx_1 + Dx_2 - Cp_1 + iBp_1 + iDp_2 + iCx_1 \end{pmatrix}$$

ANALOGY: 2-State Schrodinger: $i\hbar\partial_t|\Psi(t)\rangle = \mathbf{H}|\Psi(t)\rangle$ versus Classical 2D-HO: $\partial_t^2\mathbf{x} = -\mathbf{K}\cdot\mathbf{x}$

(Review of Lect. 23)

$$i\hbar|\dot{\Psi}(t)\rangle = \mathbf{H}|\Psi(t)\rangle$$

$$|\ddot{\mathbf{x}}\rangle = -\mathbf{K}\cdot|\mathbf{x}\rangle$$

First start with 2-by-2 Hermitian (self-conjugate) matrix

$$\mathbf{H} = \begin{pmatrix} A & B-iC \\ B+iC & D \end{pmatrix} = \mathbf{H}^\dagger$$

that operates on 2-D complex Dirac ket vector $|\Psi\rangle$.

$$|\Psi\rangle = \begin{pmatrix} \Psi_1 \\ \Psi_2 \end{pmatrix} = \begin{pmatrix} x_1 + ip_1 \\ x_2 + ip_2 \end{pmatrix} = \begin{pmatrix} a_1 \\ a_2 \end{pmatrix}$$

Separate real x_k and imaginary p_k parts of Ψ_k amplitudes

to convert the **complex 1st-order equation $i\partial_t\Psi = \mathbf{H}\Psi$**

into pairs of *real* 1st-order differential equations.

$$\dot{x}_1 = Ap_1 + Bp_2 - Cx_2 \quad \dot{p}_1 = -Ax_1 - Bx_2 - Cp_2$$

$$\dot{x}_2 = Bp_1 + Dp_2 + Cx_1 \quad \dot{p}_2 = -Bx_1 - Dx_2 + Cp_1$$

Then start with classical Hamiltonian. (Designed to give same result.)

$$H_c = \frac{A}{2}(p_1^2 + x_1^2) + B(x_1x_2 + p_1p_2) + C(x_1p_2 - x_2p_1) + \frac{D}{2}(p_2^2 + x_2^2)$$

ANALOGY: 2-State Schrodinger: $i\hbar\partial_t|\Psi(t)\rangle = \mathbf{H}|\Psi(t)\rangle$ versus Classical 2D-HO: $\partial_t^2\mathbf{x} = -\mathbf{K}\cdot\mathbf{x}$

(Review of Lect. 23)

$$i\hbar|\dot{\Psi}(t)\rangle = \mathbf{H}|\Psi(t)\rangle$$

$$|\ddot{\mathbf{x}}\rangle = -\mathbf{K}\cdot|\mathbf{x}\rangle$$

First start with 2-by-2 Hermitian (self-conjugate) matrix

$$\mathbf{H} = \begin{pmatrix} A & B-iC \\ B+iC & D \end{pmatrix} = \mathbf{H}^\dagger$$

that operates on 2-D complex Dirac ket vector $|\Psi\rangle$.

$$|\Psi\rangle = \begin{pmatrix} \Psi_1 \\ \Psi_2 \end{pmatrix} = \begin{pmatrix} x_1 + ip_1 \\ x_2 + ip_2 \end{pmatrix} = \begin{pmatrix} a_1 \\ a_2 \end{pmatrix}$$

Separate real x_k and imaginary p_k parts of Ψ_k amplitudes

to convert the **complex 1st-order equation $i\partial_t\Psi = \mathbf{H}\Psi$**

into pairs of **real 1st-order differential equations**.

$$\dot{x}_1 = Ap_1 + Bp_2 - Cx_2 \quad \dot{p}_1 = -Ax_1 - Bx_2 - Cp_2$$

$$\dot{x}_2 = Bp_1 + Dp_2 + Cx_1 \quad \dot{p}_2 = -Bx_1 - Dx_2 + Cp_1$$

Then start with classical Hamiltonian. **(Designed to give same result.)**

$$H_c = \frac{A}{2}(p_1^2 + x_1^2) + B(x_1x_2 + p_1p_2) + C(x_1p_2 - x_2p_1) + \frac{D}{2}(p_2^2 + x_2^2)$$

Then Hamilton's equations of motion are the following.

*For constant
A, B, C, and D*

$$\dot{x}_1 = \frac{\partial H_c}{\partial p_1} = Ap_1 + Bp_2 - Cx_2 \quad \dot{p}_1 = -\frac{\partial H_c}{\partial x_1} = -(Ax_1 + Bx_2 + Cp_2)$$

$$\dot{x}_2 = \frac{\partial H_c}{\partial p_2} = Bp_1 + Dp_2 + Cx_1 \quad \dot{p}_2 = -\frac{\partial H_c}{\partial x_2} = -(Bx_1 + Dx_2 - Cp_1)$$

*ANALOGY: 2-State Schrodinger: $i\hbar\partial_t|\Psi(t)\rangle = \mathbf{H}|\Psi(t)\rangle$ versus **Classical 2D-HO: $\partial^2_t\mathbf{x} = -\mathbf{K}\cdot\mathbf{x}$***

(Review of Lect. 23)

$$i\hbar|\dot{\Psi}(t)\rangle = \mathbf{H}|\Psi(t)\rangle$$

$$|\ddot{\mathbf{x}}\rangle = -\mathbf{K}\cdot|\mathbf{x}\rangle$$

First start with 2-by-2 Hermitian (self-conjugate) matrix

$$\mathbf{H} = \begin{pmatrix} A & B-iC \\ B+iC & D \end{pmatrix} = \mathbf{H}^\dagger$$

that operates on 2-D complex Dirac ket vector $|\Psi\rangle$.

$$|\Psi\rangle = \begin{pmatrix} \Psi_1 \\ \Psi_2 \end{pmatrix} = \begin{pmatrix} x_1 + ip_1 \\ x_2 + ip_2 \end{pmatrix} = \begin{pmatrix} a_1 \\ a_2 \end{pmatrix}$$

Separate real x_k and imaginary p_k parts of Ψ_k amplitudes

to convert the **complex 1st-order equation $i\partial_t\Psi = \mathbf{H}\Psi$**

into pairs of *real* 1st-order differential equations.

$$\dot{x}_1 = Ap_1 + Bp_2 - Cx_2 \quad \dot{p}_1 = -Ax_1 - Bx_2 - Cp_2$$

$$\dot{x}_2 = Bp_1 + Dp_2 + Cx_1 \quad \dot{p}_2 = -Bx_1 - Dx_2 + Cp_1$$

*QM vs. Classical
Equations are
identical*

Then start with classical Hamiltonian. **(Designed to give same result.)**

$$H_c = \frac{A}{2}(p_1^2 + x_1^2) + B(x_1x_2 + p_1p_2) + C(x_1p_2 - x_2p_1) + \frac{D}{2}(p_2^2 + x_2^2)$$

Then Hamilton's equations of motion are the following.

*For constant
A, B, C, and D*

$$\dot{x}_1 = \frac{\partial H_c}{\partial p_1} = Ap_1 + Bp_2 - Cx_2$$

$$\dot{p}_1 = -\frac{\partial H_c}{\partial x_1} = -(Ax_1 + Bx_2 + Cp_2)$$

$$\dot{x}_2 = \frac{\partial H_c}{\partial p_2} = Bp_1 + Dp_2 + Cx_1$$

$$\dot{p}_2 = -\frac{\partial H_c}{\partial x_2} = -(Bx_1 + Dx_2 - Cp_1)$$

*ANALOGY: 2-State Schrodinger: $i\hbar\partial_t|\Psi(t)\rangle = \mathbf{H}|\Psi(t)\rangle$ versus **Classical 2D-HO: $\partial^2_t\mathbf{x} = -\mathbf{K}\cdot\mathbf{x}$***

(Review of Lect. 23)

$$i\hbar|\dot{\Psi}(t)\rangle = \mathbf{H}|\Psi(t)\rangle$$

$$|\ddot{\mathbf{x}}\rangle = -\mathbf{K}\cdot|\mathbf{x}\rangle$$

First start with 2-by-2 Hermitian (self-conjugate) matrix

$$\mathbf{H} = \begin{pmatrix} A & B-iC \\ B+iC & D \end{pmatrix} = \mathbf{H}^\dagger$$

that operates on 2-D complex Dirac ket vector $|\Psi\rangle$.

$$|\Psi\rangle = \begin{pmatrix} \Psi_1 \\ \Psi_2 \end{pmatrix} = \begin{pmatrix} x_1 + ip_1 \\ x_2 + ip_2 \end{pmatrix} = \begin{pmatrix} a_1 \\ a_2 \end{pmatrix}$$

Separate real x_k and imaginary p_k parts of Ψ_k amplitudes

to convert the **complex 1st-order equation $i\partial_t\Psi = \mathbf{H}\Psi$**

into pairs of real 1st-order differential equations.

$$\begin{cases} \dot{x}_1 = Ap_1 + Bp_2 - Cx_2 \\ \dot{x}_2 = Bp_1 + Dp_2 + Cx_1 \end{cases} \quad \begin{cases} \dot{p}_1 = -Ax_1 - Bx_2 - Cp_2 \\ \dot{p}_2 = -Bx_1 - Dx_2 + Cp_1 \end{cases}$$

*QM vs. Classical
Equations are
identical*

$$\begin{aligned} \dot{x}_1 &= \frac{\partial H_c}{\partial p_1} = Ap_1 + Bp_2 - Cx_2 & \dot{p}_1 &= -\frac{\partial H_c}{\partial x_1} = -(Ax_1 + Bx_2 + Cp_2) \\ \dot{x}_2 &= \frac{\partial H_c}{\partial p_2} = Bp_1 + Dp_2 + Cx_1 & \dot{p}_2 &= -\frac{\partial H_c}{\partial x_2} = -(Bx_1 + Dx_2 - Cp_1) \end{aligned}$$

Finally a 2nd time derivative (Assume constant A, B, D , and **let $C=0$**) gives 2nd-order classical Newton-Hooke-like equation: $|\ddot{\mathbf{x}}\rangle = -\mathbf{K}\cdot|\mathbf{x}\rangle$

$$\begin{aligned} \ddot{x}_1 &= A\dot{p}_1 + B\dot{p}_2 - C\dot{x}_2 \\ &= -A(Ax_1 + Bx_2 + Cp_2) - B(Bx_1 + Dx_2 - Cp_1) - C(Bp_1 + Dp_2 + Cx_1) \\ &= -(A^2 + B^2 + C^2)x_1 - (AB + BD)x_2 - C(A + D)p_2 \end{aligned}$$

$$\begin{aligned} \ddot{x}_2 &= B\dot{p}_1 + D\dot{p}_2 + C\dot{x}_1 \\ &= -B(Ax_1 + Bx_2 + Cp_2) - D(Bx_1 + Dx_2 - Cp_1) + C(Ap_1 + Bp_2 - Cx_2) \\ &= -(AB + BD)x_1 - (B^2 + D^2 + C^2)x_2 + C(A + D)p_1 \end{aligned}$$

*For constant
 A, B, C , and D*

*For constant
 A, B, C , and D*

ANALOGY: 2-State Schrodinger: $i\hbar\partial_t|\Psi(t)\rangle = \mathbf{H}|\Psi(t)\rangle$ versus *Classical 2D-HO: $\partial_t^2\mathbf{x} = -\mathbf{K}\cdot\mathbf{x}$*

(Review of Lect. 23)

$$i\hbar|\dot{\Psi}(t)\rangle = \mathbf{H}|\Psi(t)\rangle$$

$$|\ddot{\mathbf{x}}\rangle = -\mathbf{K}\cdot|\mathbf{x}\rangle$$

First start with 2-by-2 Hermitian (self-conjugate) matrix

$$\mathbf{H} = \begin{pmatrix} A & B-iC \\ B+iC & D \end{pmatrix} = \mathbf{H}^\dagger$$

that operates on 2-D complex Dirac ket vector $|\Psi\rangle$.

$$|\Psi\rangle = \begin{pmatrix} \Psi_1 \\ \Psi_2 \end{pmatrix} = \begin{pmatrix} x_1 + ip_1 \\ x_2 + ip_2 \end{pmatrix} = \begin{pmatrix} a_1 \\ a_2 \end{pmatrix}$$

Separate real x_k and imaginary p_k parts of Ψ_k amplitudes

to convert the **complex 1st-order equation $i\partial_t\Psi = \mathbf{H}\Psi$**

into pairs of **real 1st-order differential equations.**

$$\begin{cases} \dot{x}_1 = Ap_1 + Bp_2 - Cx_2 \\ \dot{x}_2 = Bp_1 + Dp_2 + Cx_1 \end{cases} \quad \begin{cases} \dot{p}_1 = -Ax_1 - Bx_2 - Cp_2 \\ \dot{p}_2 = -Bx_1 - Dx_2 + Cp_1 \end{cases}$$

*QM vs. Classical
Equations are
identical*

$$\begin{aligned} \dot{x}_1 &= \frac{\partial H_c}{\partial p_1} = Ap_1 + Bp_2 - Cx_2 & \dot{p}_1 &= -\frac{\partial H_c}{\partial x_1} = -(Ax_1 + Bx_2 + Cp_2) \\ \dot{x}_2 &= \frac{\partial H_c}{\partial p_2} = Bp_1 + Dp_2 + Cx_1 & \dot{p}_2 &= -\frac{\partial H_c}{\partial x_2} = -(Bx_1 + Dx_2 - Cp_1) \end{aligned}$$

Finally a 2nd time derivative (Assume *constant* A, B, D , and *let $C=0$*) gives 2nd-order classical Newton-Hooke-like equation: $|\ddot{\mathbf{x}}\rangle = -\mathbf{K}\cdot|\mathbf{x}\rangle$

$$\begin{aligned} \ddot{x}_1 &= A\dot{p}_1 + B\dot{p}_2 - C\dot{x}_2 \\ &= -A(Ax_1 + Bx_2 + Cp_2) - B(Bx_1 + Dx_2 - Cp_1) - C(Bp_1 + Dp_2 + Cx_1) \\ &= -(A^2 + B^2 + C^2)x_1 - (AB + BD)x_2 - C(A + D)p_2 \end{aligned}$$

$$\begin{aligned} \ddot{x}_2 &= B\dot{p}_1 + D\dot{p}_2 + C\dot{x}_1 \\ &= -B(Ax_1 + Bx_2 + Cp_2) - D(Bx_1 + Dx_2 - Cp_1) + C(Ap_1 + Bp_2 - Cx_2) \\ &= -(AB + BD)x_1 - (B^2 + D^2 + C^2)x_2 + C(A + D)p_1 \end{aligned}$$

*For constant
 A, B, C , and D*

*For constant
 A, B, C , and D*

$$\begin{pmatrix} \ddot{x}_1 \\ \ddot{x}_2 \end{pmatrix} = -\begin{pmatrix} A^2 + B^2 & AB + BD \\ AB + BD & B^2 + D^2 \end{pmatrix} \begin{pmatrix} x_1 \\ x_2 \end{pmatrix}$$

*For $C=0$
Is form of 2D Hooke
harmonic oscillator*

$$\frac{\partial^2}{\partial t^2} \begin{pmatrix} x_1 \\ x_2 \end{pmatrix} \equiv \begin{pmatrix} \ddot{x}_1 \\ \ddot{x}_2 \end{pmatrix} = -\begin{pmatrix} K_{11} & K_{12} \\ K_{21} & K_{22} \end{pmatrix} \begin{pmatrix} x_1 \\ x_2 \end{pmatrix}$$

ANALOGY: 2-State Schrodinger: $i\hbar\partial_t|\Psi(t)\rangle = \mathbf{H}|\Psi(t)\rangle$ versus **Classical 2D-HO:** $\partial_t^2\mathbf{x} = -\mathbf{K}\cdot\mathbf{x}$

(Review of Lect. 23)

$$i\hbar|\dot{\Psi}(t)\rangle = \mathbf{H}|\Psi(t)\rangle$$

$$|\ddot{\mathbf{x}}\rangle = -\mathbf{K}\cdot|\mathbf{x}\rangle$$

First start with 2-by-2 Hermitian (self-conjugate) matrix

$$\mathbf{H} = \begin{pmatrix} A & B-iC \\ B+iC & D \end{pmatrix} = \mathbf{H}^\dagger$$

that operates on 2-D complex Dirac ket vector $|\Psi\rangle$.

$$|\Psi\rangle = \begin{pmatrix} \Psi_1 \\ \Psi_2 \end{pmatrix} = \begin{pmatrix} x_1 + ip_1 \\ x_2 + ip_2 \end{pmatrix} = \begin{pmatrix} a_1 \\ a_2 \end{pmatrix}$$

Separate real x_k and imaginary p_k parts of Ψ_k amplitudes

to convert the complex 1st-order equation $i\partial_t\Psi = \mathbf{H}\Psi$

into pairs of real 1st-order differential equations.

$$\begin{cases} \dot{x}_1 = Ap_1 + Bp_2 - Cx_2 \\ \dot{x}_2 = Bp_1 + Dp_2 + Cx_1 \end{cases} \quad \begin{cases} \dot{p}_1 = -Ax_1 - Bx_2 - Cp_2 \\ \dot{p}_2 = -Bx_1 - Dx_2 + Cp_1 \end{cases}$$

*QM vs. Classical
Equations are
identical*

$$H_c = \frac{A}{2}(p_1^2 + x_1^2) + B(x_1x_2 + p_1p_2) + C(x_1p_2 - x_2p_1) + \frac{D}{2}(p_2^2 + x_2^2)$$

Then start with classical Hamiltonian. (Designed to give same result.)

Then Hamilton's equations of motion are the following.

*For constant
A, B, C, and D*

$$\begin{aligned} \dot{x}_1 &= \frac{\partial H_c}{\partial p_1} = Ap_1 + Bp_2 - Cx_2 & \dot{p}_1 &= -\frac{\partial H_c}{\partial x_1} = -(Ax_1 + Bx_2 + Cp_2) \\ \dot{x}_2 &= \frac{\partial H_c}{\partial p_2} = Bp_1 + Dp_2 + Cx_1 & \dot{p}_2 &= -\frac{\partial H_c}{\partial x_2} = -(Bx_1 + Dx_2 - Cp_1) \end{aligned}$$

Finally a 2nd time derivative (Assume constant A, B, D , and **let $C=0$**) gives 2nd-order classical Newton-Hooke-like equation: $|\ddot{\mathbf{x}}\rangle = -\mathbf{K}\cdot|\mathbf{x}\rangle$

$$\begin{aligned} \ddot{x}_1 &= A\dot{p}_1 + B\dot{p}_2 - C\dot{x}_2 \\ &= -A(Ax_1 + Bx_2 + Cp_2) - B(Bx_1 + Dx_2 - Cp_1) - C(Bp_1 + Dp_2 + Cx_1) \\ &= -(A^2 + B^2 + C^2)x_1 - (AB + BD)x_2 - C(A + D)p_2 \end{aligned}$$

$$\begin{aligned} \ddot{x}_2 &= B\dot{p}_1 + D\dot{p}_2 + C\dot{x}_1 \\ &= -B(Ax_1 + Bx_2 + Cp_2) - D(Bx_1 + Dx_2 - Cp_1) + C(Ap_1 + Bp_2 - Cx_2) \\ &= -(AB + BD)x_1 - (B^2 + D^2 + C^2)x_2 + C(A + D)p_1 \end{aligned}$$

*For constant
A, B, C, and D*

$$\begin{pmatrix} \ddot{x}_1 \\ \ddot{x}_2 \end{pmatrix} = -\begin{pmatrix} A^2 + B^2 & AB + BD \\ AB + BD & B^2 + D^2 \end{pmatrix} \begin{pmatrix} x_1 \\ x_2 \end{pmatrix}$$

*For $C=0$
Is form of 2D Hooke
harmonic oscillator*

$$\frac{\partial^2}{\partial t^2} \begin{pmatrix} x_1 \\ x_2 \end{pmatrix} \equiv \begin{pmatrix} \ddot{x}_1 \\ \ddot{x}_2 \end{pmatrix} = -\begin{pmatrix} K_{11} & K_{12} \\ K_{21} & K_{22} \end{pmatrix} \begin{pmatrix} x_1 \\ x_2 \end{pmatrix}$$

Here is an operator view of the QM-Classical connection: Take Schrodinger operator $i\partial_t = \mathbf{H}$ (with $C=0$) and square it!

$$i\frac{\partial}{\partial t} = \begin{pmatrix} A & B \\ B & D \end{pmatrix} \Rightarrow \left(i\frac{\partial}{\partial t}\right)^2 = \begin{pmatrix} A & B \\ B & D \end{pmatrix}^2 \Rightarrow -\frac{\partial^2}{\partial t^2} = \begin{pmatrix} A^2 + B^2 & AB + BD \\ AB + BD & B^2 + D^2 \end{pmatrix}$$

ANALOGY: 2-State Schrodinger: $i\hbar\partial_t|\Psi(t)\rangle = \mathbf{H}|\Psi(t)\rangle$ versus *Classical 2D-HO: $\partial^2_t\mathbf{x} = -\mathbf{K}\cdot\mathbf{x}$*

(Review of Lect. 23)

$$i\hbar|\dot{\Psi}(t)\rangle = \mathbf{H}|\Psi(t)\rangle$$

$$|\ddot{\mathbf{x}}\rangle = -\mathbf{K}\cdot|\mathbf{x}\rangle$$

First start with 2-by-2 Hermitian (self-conjugate) matrix

$$\mathbf{H} = \begin{pmatrix} A & B - iC \\ B + iC & D \end{pmatrix} = \mathbf{H}^\dagger$$

that operates on 2-D complex Dirac ket vector $|\Psi\rangle$.

$$|\Psi\rangle = \begin{pmatrix} \Psi_1 \\ \Psi_2 \end{pmatrix} = \begin{pmatrix} x_1 + ip_1 \\ x_2 + ip_2 \end{pmatrix} = \begin{pmatrix} a_1 \\ a_2 \end{pmatrix}$$

Separate real x_k and imaginary p_k parts of Ψ_k amplitudes

to convert the **complex 1st-order equation $i\partial_t\Psi = \mathbf{H}\Psi$**

into pairs of **real 1st-order differential equations**.

$$\begin{cases} \dot{x}_1 = Ap_1 + Bp_2 - Cx_2 \\ \dot{x}_2 = Bp_1 + Dp_2 + Cx_1 \end{cases} \quad \begin{cases} \dot{p}_1 = -Ax_1 - Bx_2 - Cp_2 \\ \dot{p}_2 = -Bx_1 - Dx_2 + Cp_1 \end{cases}$$

QM vs. Classical Equations are identical

Then start with classical Hamiltonian. **(Designed to give same result.)**

$$H_c = \frac{A}{2}(p_1^2 + x_1^2) + B(x_1x_2 + p_1p_2) + C(x_1p_2 - x_2p_1) + \frac{D}{2}(p_2^2 + x_2^2)$$

Then Hamilton's equations of motion are the following.

For constant A, B, C, and D

$$\begin{aligned} \dot{x}_1 &= \frac{\partial H_c}{\partial p_1} = Ap_1 + Bp_2 - Cx_2 & \dot{p}_1 &= -\frac{\partial H_c}{\partial x_1} = -(Ax_1 + Bx_2 + Cp_2) \\ \dot{x}_2 &= \frac{\partial H_c}{\partial p_2} = Bp_1 + Dp_2 + Cx_1 & \dot{p}_2 &= -\frac{\partial H_c}{\partial x_2} = -(Bx_1 + Dx_2 - Cp_1) \end{aligned}$$

Finally a 2nd time derivative (Assume **constant A, B, D, and let C=0**) gives 2nd-order classical Newton-Hooke-like equation: $|\ddot{\mathbf{x}}\rangle = -\mathbf{K}\cdot|\mathbf{x}\rangle$

$$\begin{aligned} \ddot{x}_1 &= A\dot{p}_1 + B\dot{p}_2 - C\dot{x}_2 \\ &= -A(Ax_1 + Bx_2 + Cp_2) - B(Bx_1 + Dx_2 - Cp_1) - C(Bp_1 + Dp_2 + Cx_1) \\ &= -(A^2 + B^2 + C^2)x_1 - (AB + BD)x_2 - C(A + D)p_2 \end{aligned}$$

$$\begin{aligned} \ddot{x}_2 &= B\dot{p}_1 + D\dot{p}_2 + C\dot{x}_1 \\ &= -B(Ax_1 + Bx_2 + Cp_2) - D(Bx_1 + Dx_2 - Cp_1) + C(Ap_1 + Bp_2 - Cx_2) \\ &= -(AB + BD)x_1 - (B^2 + D^2 + C^2)x_2 + C(A + D)p_1 \end{aligned}$$

For constant A, B, C, and D

$$\begin{pmatrix} \ddot{x}_1 \\ \ddot{x}_2 \end{pmatrix} = -\begin{pmatrix} A^2 + B^2 & AB + BD \\ AB + BD & B^2 + D^2 \end{pmatrix} \begin{pmatrix} x_1 \\ x_2 \end{pmatrix}$$

For C=0 Is form of 2D Hooke harmonic oscillator

$$\frac{\partial^2}{\partial t^2} \begin{pmatrix} x_1 \\ x_2 \end{pmatrix} \equiv \begin{pmatrix} \ddot{x}_1 \\ \ddot{x}_2 \end{pmatrix} = -\begin{pmatrix} K_{11} & K_{12} \\ K_{21} & K_{22} \end{pmatrix} \begin{pmatrix} x_1 \\ x_2 \end{pmatrix}$$

Here is an operator view of the QM-Classical connection: Take Schrodinger operator $i\partial_t = \mathbf{H}$ (with **C=0**) and square it!

$$i\frac{\partial}{\partial t} = \begin{pmatrix} A & B \\ B & D \end{pmatrix} \Rightarrow \left(i\frac{\partial}{\partial t}\right)^2 = \begin{pmatrix} A & B \\ B & D \end{pmatrix}^2 \Rightarrow -\frac{\partial^2}{\partial t^2} = \begin{pmatrix} A^2 + B^2 & AB + BD \\ AB + BD & B^2 + D^2 \end{pmatrix}$$

Conclusion: 2-state Schro-equation $i\hbar\frac{\partial}{\partial t}|\Psi(t)\rangle = \mathbf{H}|\Psi(t)\rangle$ is like "square-root" of Newton-Hooke. $\sqrt{|\ddot{\mathbf{x}}\rangle = -\mathbf{K}\cdot|\mathbf{x}\rangle}$

ANALOGY: 2-State Schrodinger: $i\hbar\partial_t|\Psi(t)\rangle = \mathbf{H}|\Psi(t)\rangle$ versus *Classical 2DHO: $\partial^2_t \mathbf{x} = -\mathbf{K} \cdot \mathbf{x}$*

(Review of Lect. 23)

$$i\hbar|\dot{\Psi}(t)\rangle = \mathbf{H}|\Psi(t)\rangle$$

$$|\ddot{\mathbf{x}}\rangle = -\mathbf{K} \cdot |\mathbf{x}\rangle$$

First start with 2-by-2 Hermitian (self-conjugate) matrix

$$\mathbf{H} = \begin{pmatrix} A & B - iC \\ B + iC & D \end{pmatrix} = \mathbf{H}^\dagger$$

that operates on 2-D complex Dirac ket vector $|\Psi\rangle$.

$$|\Psi\rangle = \begin{pmatrix} \Psi_1 \\ \Psi_2 \end{pmatrix} = \begin{pmatrix} x_1 + ip_1 \\ x_2 + ip_2 \end{pmatrix} = \begin{pmatrix} a_1 \\ a_2 \end{pmatrix}$$

Separate real x_k and imaginary p_k parts of Ψ_k amplitudes to convert the complex 1st-order equation $i\partial_t\Psi = \mathbf{H}\Psi$ into pairs of real real 1st-order differential equations.

$$\begin{cases} \dot{x}_1 = Ap_1 + Bp_2 - Cx_2 \\ \dot{x}_2 = Bp_1 + Dp_2 + Cx_1 \end{cases} \quad \begin{cases} \dot{p}_1 = -Ax_1 - Bx_2 - Cp_2 \\ \dot{p}_2 = -Bx_1 - Dx_2 + Cp_1 \end{cases}$$

QM vs. Classical Equations are identical

$$\begin{aligned} \dot{x}_1 &= \frac{\partial H_c}{\partial p_1} = Ap_1 + Bp_2 - Cx_2 & \dot{p}_1 &= -\frac{\partial H_c}{\partial x_1} = -(Ax_1 + Bx_2 + Cp_2) \\ \dot{x}_2 &= \frac{\partial H_c}{\partial p_2} = Bp_1 + Dp_2 + Cx_1 & \dot{p}_2 &= -\frac{\partial H_c}{\partial x_2} = -(Bx_1 + Dx_2 - Cp_1) \end{aligned}$$

Then Hamilton's equations of motion are the following.

For constant A, B, C, and D

Finally a 2nd time derivative (Assume *constant* A, B, D , and *let* $C=0$) gives 2nd-order classical Newton-Hooke-like equation: $|\ddot{\mathbf{x}}\rangle = -\mathbf{K} \cdot |\mathbf{x}\rangle$

$$\begin{aligned} \ddot{x}_1 &= A\dot{p}_1 + B\dot{p}_2 - C\dot{x}_2 \\ &= -A(Ax_1 + Bx_2 + Cp_2) - B(Bx_1 + Dx_2 - Cp_1) - C(Bp_1 + Dp_2 + Cx_1) \\ &= -(A^2 + B^2 + C^2)x_1 - (AB + BD)x_2 - C(A + D)p_2 \end{aligned}$$

$$\begin{aligned} \ddot{x}_2 &= B\dot{p}_1 + D\dot{p}_2 + C\dot{x}_1 \\ &= -B(Ax_1 + Bx_2 + Cp_2) - D(Bx_1 + Dx_2 - Cp_1) + C(Ap_1 + Bp_2 - Cx_2) \\ &= -(AB + BD)x_1 - (B^2 + D^2 + C^2)x_2 + C(A + D)p_1 \end{aligned}$$

For constant A, B, C, and D

$$\begin{pmatrix} \ddot{x}_1 \\ \ddot{x}_2 \end{pmatrix} = -\begin{pmatrix} A^2 + B^2 & AB + BD \\ AB + BD & B^2 + D^2 \end{pmatrix} \begin{pmatrix} x_1 \\ x_2 \end{pmatrix}$$

For C=0 Is form of 2D Hooke harmonic oscillator

$$\frac{\partial^2}{\partial t^2} \begin{pmatrix} x_1 \\ x_2 \end{pmatrix} \equiv \begin{pmatrix} \ddot{x}_1 \\ \ddot{x}_2 \end{pmatrix} = -\begin{pmatrix} K_{11} & K_{12} \\ K_{21} & K_{22} \end{pmatrix} \begin{pmatrix} x_1 \\ x_2 \end{pmatrix}$$

Here is an operator view of the QM-Classical connection: Take Schrodinger operator $i\partial_t = \mathbf{H}$ (with $C \neq 0$) and square it!

$$i\frac{\partial}{\partial t} = \begin{pmatrix} A & B - iC \\ B + iC & D \end{pmatrix} \Rightarrow \left(i\frac{\partial}{\partial t}\right)^2 = \begin{pmatrix} A & B - iC \\ B + iC & D \end{pmatrix}^2 \Rightarrow -\frac{\partial^2}{\partial t^2} = \begin{pmatrix} A^2 + B^2 + C^2 & AB + BD - i(AC + CD) \\ AB + BD + i(AC + CD) & B^2 + D^2 + C^2 \end{pmatrix}$$

Conclusion: 2-state Schro-equation $i\hbar\frac{\partial}{\partial t}|\Psi(t)\rangle = \mathbf{H}|\Psi(t)\rangle$ is like "square-root" of Newton-Hooke. $\sqrt{|\ddot{\mathbf{x}}\rangle = -\mathbf{K} \cdot |\mathbf{x}\rangle}$

ANALOGY: 2-State Schrodinger: $i\hbar\partial_t|\Psi(t)\rangle = \mathbf{H}|\Psi(t)\rangle$ versus Classical 2D-HO: $\partial_t^2\mathbf{x} = -\mathbf{K}\cdot\mathbf{x}$

➔ *Hamilton-Pauli spinor symmetry (σ -expansion in **ABCD**-Types) $\mathbf{H} = \omega_\mu \sigma_\mu$*

Derive σ -exponential time evolution (or revolution) operator $\mathbf{U} = e^{-i\mathbf{H}t} = e^{-i\sigma_\mu \omega_\mu t}$

Spinor arithmetic like complex arithmetic

Spinor vector algebra like complex vector algebra

Spinor exponentials like complex exponentials (“Crazy-Thing”-Theorem)

Geometry of evolution (or revolution) operator $\mathbf{U} = e^{-i\mathbf{H}t} = e^{-i\sigma_\mu \omega_\mu t}$

The “mysterious” factors of 2 (or 1/2): 2D Spinor vs 3D Spin Vector space

2D Spinor vs 3D vector rotation

NMR Hamiltonian: 3D Spin Moment \mathbf{m} in \mathbf{B} field

ABCD Symmetry operator analysis and U(2) spinors

Decompose the Hamiltonian operator \mathbf{H} into four *ABCD symmetry operators*

(Labeled to provide dynamic mnemonics as well as colorful analogies)

$$\begin{aligned} \begin{pmatrix} A & B-iC \\ B+iC & D \end{pmatrix} &= A \begin{pmatrix} 1 & 0 \\ 0 & 0 \end{pmatrix} + B \begin{pmatrix} 0 & 1 \\ 1 & 0 \end{pmatrix} + C \begin{pmatrix} 0 & -i \\ i & 0 \end{pmatrix} + D \begin{pmatrix} 0 & 0 \\ 0 & 1 \end{pmatrix} = A\mathbf{e}_{11} + B\sigma_B + C\sigma_C + D\mathbf{e}_{22} \\ &= \frac{A-D}{2} \begin{pmatrix} 1 & 0 \\ 0 & -1 \end{pmatrix} + B \begin{pmatrix} 0 & 1 \\ 1 & 0 \end{pmatrix} + C \begin{pmatrix} 0 & -i \\ i & 0 \end{pmatrix} + \frac{A+D}{2} \begin{pmatrix} 1 & 0 \\ 0 & 1 \end{pmatrix} \\ \mathbf{H} &= \frac{A-D}{2} \sigma_A + B \sigma_B + C \sigma_C + \frac{A+D}{2} \sigma_0 \end{aligned}$$

...current-carrier...

Symmetry archetypes: *A* (Asymmetric-diagonal) | *B* (Bilateral-balanced) | *C* (Chiral-circular-complex-Coriolis-cyclotron-curly...)

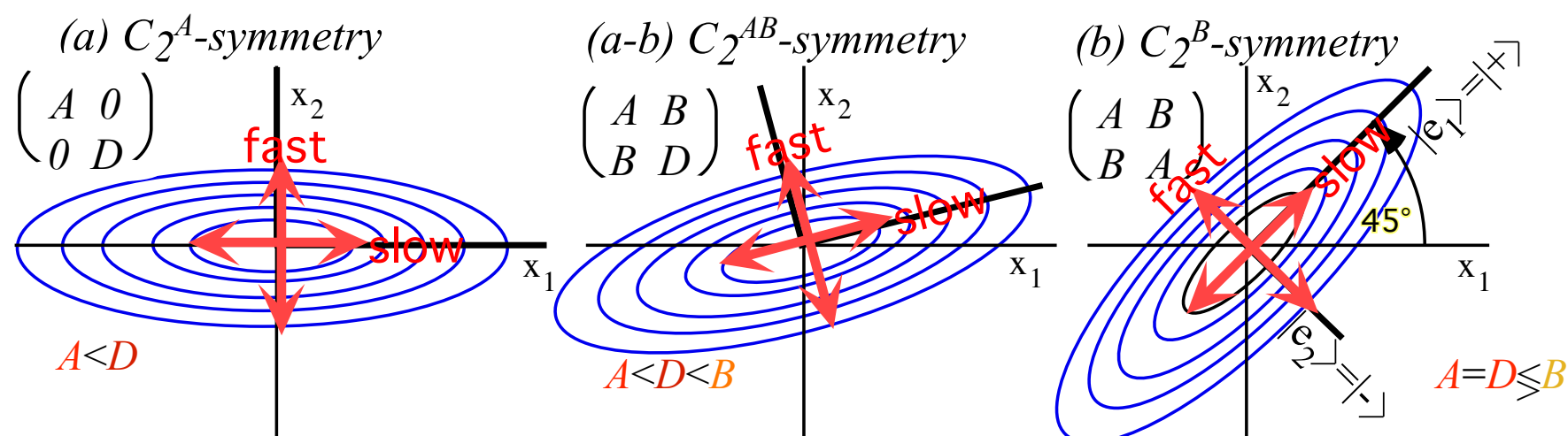

Fig. 3.4.1 Potentials for (a) C_2^A -asymmetric-diagonal, (ab) C_2^{AB} -mixed, (b) C_2^B -bilateral U(2)system.

ABCD Symmetry operator analysis and U(2) spinors

Decompose the Hamiltonian operator \mathbf{H} into four *ABCD symmetry operators*

(Labeled to provide dynamic mnemonics as well as colorful analogies)

$$\begin{aligned} \begin{pmatrix} A & B-iC \\ B+iC & D \end{pmatrix} &= A \begin{pmatrix} 1 & 0 \\ 0 & 0 \end{pmatrix} + B \begin{pmatrix} 0 & 1 \\ 1 & 0 \end{pmatrix} + C \begin{pmatrix} 0 & -i \\ i & 0 \end{pmatrix} + D \begin{pmatrix} 0 & 0 \\ 0 & 1 \end{pmatrix} = A\mathbf{e}_{11} + B\boldsymbol{\sigma}_B + C\boldsymbol{\sigma}_C + D\mathbf{e}_{22} \\ &= \frac{A-D}{2} \begin{pmatrix} 1 & 0 \\ 0 & -1 \end{pmatrix} + B \begin{pmatrix} 0 & 1 \\ 1 & 0 \end{pmatrix} + C \begin{pmatrix} 0 & -i \\ i & 0 \end{pmatrix} + \frac{A+D}{2} \begin{pmatrix} 1 & 0 \\ 0 & 1 \end{pmatrix} \\ \mathbf{H} &= \frac{A-D}{2} \boldsymbol{\sigma}_A + B \boldsymbol{\sigma}_B + C \boldsymbol{\sigma}_C + \frac{A+D}{2} \boldsymbol{\sigma}_0 \end{aligned}$$

...current-carrier...

Symmetry archetypes: *A* (Asymmetric-diagonal) | *B* (Bilateral-balanced) | *C* (Chiral-circular-complex-Coriolis-cyclotron-curly...)

The $\{\boldsymbol{\sigma}_I, \boldsymbol{\sigma}_A, \boldsymbol{\sigma}_B, \boldsymbol{\sigma}_C\}$ are best known as *Pauli-spin operators* $\{\boldsymbol{\sigma}_I = \boldsymbol{\sigma}_0, \boldsymbol{\sigma}_B = \boldsymbol{\sigma}_X, \boldsymbol{\sigma}_C = \boldsymbol{\sigma}_Y, \boldsymbol{\sigma}_A = \boldsymbol{\sigma}_Z\}$ developed in 1927.

Wolfgang Pauli (1927) Zur Quantenmechanik des magnetischen Elektrons *Zeitschrift für Physik* (43) 601-623

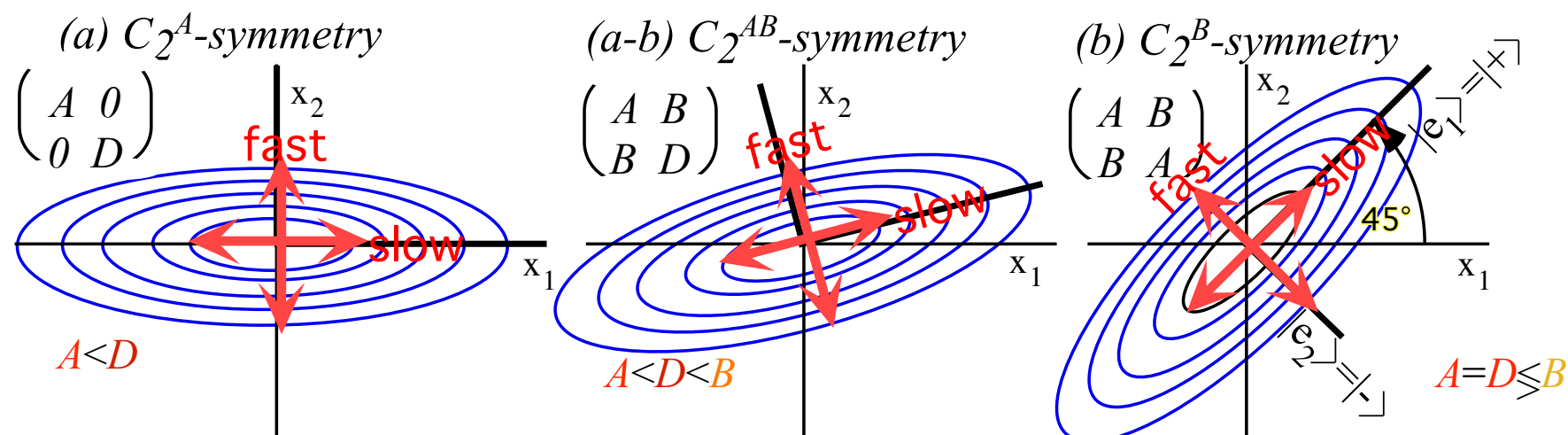

Fig. 3.4.1 Potentials for (a) C_2^A -asymmetric-diagonal, (ab) C_2^{AB} -mixed, (b) C_2^B -bilateral U(2)system.

ABCD Symmetry operator analysis and U(2) spinors

Decompose the Hamiltonian operator \mathbf{H} into four *ABCD symmetry operators*

(Labeled to provide dynamic mnemonics as well as colorful analogies)

$$\begin{pmatrix} A & B-iC \\ B+iC & D \end{pmatrix} = A \begin{pmatrix} 1 & 0 \\ 0 & 0 \end{pmatrix} + B \begin{pmatrix} 0 & 1 \\ 1 & 0 \end{pmatrix} + C \begin{pmatrix} 0 & -i \\ i & 0 \end{pmatrix} + D \begin{pmatrix} 0 & 0 \\ 0 & 1 \end{pmatrix} = A\mathbf{e}_{11} + B\sigma_B + C\sigma_C + D\mathbf{e}_{22}$$

$$= \frac{A-D}{2} \begin{pmatrix} 1 & 0 \\ 0 & -1 \end{pmatrix} + B \begin{pmatrix} 0 & 1 \\ 1 & 0 \end{pmatrix} + C \begin{pmatrix} 0 & -i \\ i & 0 \end{pmatrix} + \frac{A+D}{2} \begin{pmatrix} 1 & 0 \\ 0 & 1 \end{pmatrix}$$

$$\mathbf{H} = \frac{A-D}{2} \sigma_A + B \sigma_B + C \sigma_C + \frac{A+D}{2} \sigma_0 \quad \dots\text{current-carrier...}$$

Symmetry archetypes: *A (Asymmetric-diagonal)* | *B (Bilateral-balanced)* | *C (Chiral-circular-complex-Coriolis-cyclotron-curly...)*

The $\{\sigma_I, \sigma_A, \sigma_B, \sigma_C\}$ are best known as *Pauli-spin operators* $\{\sigma_I = \sigma_0, \sigma_B = \sigma_X, \sigma_C = \sigma_Y, \sigma_A = \sigma_Z\}$ developed in 1927.

Wolfgang Pauli (1927) Zur Quantenmechanik des magnetischen Elektrons *Zeitschrift für Physik* (43) 601-623

In 1843 Hamilton invents *quaternions* $\{\mathbf{1}, \mathbf{i}, \mathbf{j}, \mathbf{k}\}$. σ_μ related by *i*-factor: $\{\sigma_I = \mathbf{1} = \sigma_0, i\sigma_B = \mathbf{i} = i\sigma_X, i\sigma_C = \mathbf{j} = i\sigma_Y, i\sigma_A = \mathbf{k} = i\sigma_Z\}$.

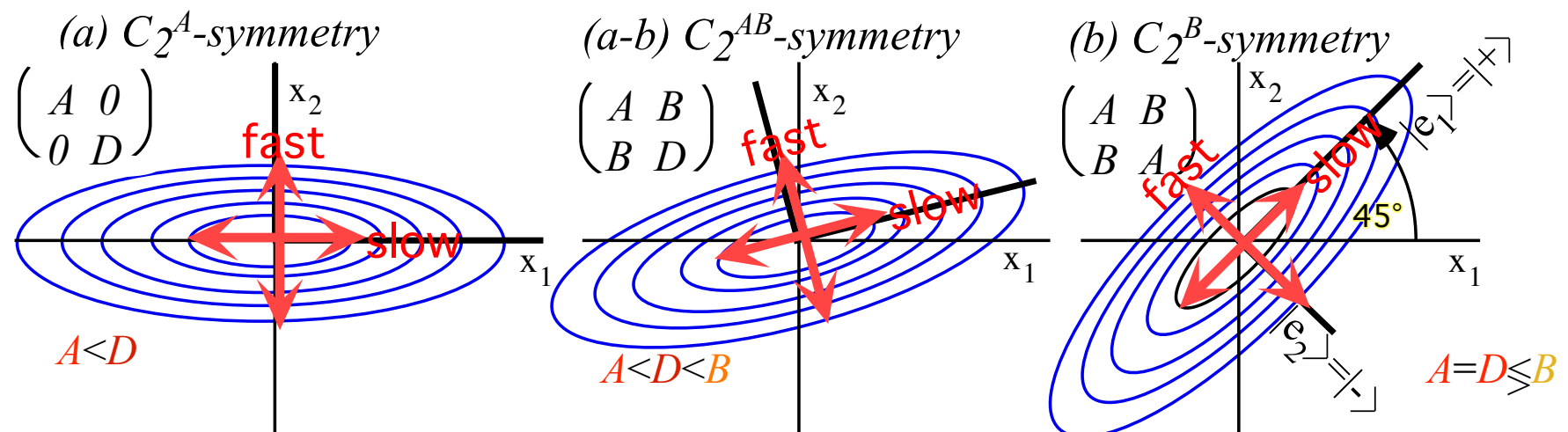

Fig. 3.4.1 Potentials for (a) C_2^A -asymmetric-diagonal, (ab) C_2^{AB} -mixed, (b) C_2^B -bilateral U(2)system.

ABCD Symmetry operator analysis and U(2) spinors

Decompose the Hamiltonian operator \mathbf{H} into four *ABCD symmetry operators*
 (Labeled to provide dynamic mnemonics as well as colorful analogies)

$$\begin{pmatrix} A & B-iC \\ B+iC & D \end{pmatrix} = A \begin{pmatrix} 1 & 0 \\ 0 & 0 \end{pmatrix} + B \begin{pmatrix} 0 & 1 \\ 1 & 0 \end{pmatrix} + C \begin{pmatrix} 0 & -i \\ i & 0 \end{pmatrix} + D \begin{pmatrix} 0 & 0 \\ 0 & 1 \end{pmatrix} = A\mathbf{e}_{11} + B\sigma_B + C\sigma_C + D\mathbf{e}_{22}$$

$$= \frac{A-D}{2} \begin{pmatrix} 1 & 0 \\ 0 & -1 \end{pmatrix} + B \begin{pmatrix} 0 & 1 \\ 1 & 0 \end{pmatrix} + C \begin{pmatrix} 0 & -i \\ i & 0 \end{pmatrix} + \frac{A+D}{2} \begin{pmatrix} 1 & 0 \\ 0 & 1 \end{pmatrix}$$

$$\mathbf{H} = \frac{A-D}{2} \sigma_A + B \sigma_B + C \sigma_C + \frac{A+D}{2} \sigma_0 \quad \dots\text{current-carrier...}$$

Symmetry archetypes: *A (Asymmetric-diagonal)* | *B (Bilateral-balanced)* | *C (Chiral-circular-complex-Coriolis-cyclotron-curly...)*

The $\{\sigma_I, \sigma_A, \sigma_B, \sigma_C\}$ are best known as *Pauli-spin operators* $\{\sigma_I = \sigma_0, \sigma_B = \sigma_X, \sigma_C = \sigma_Y, \sigma_A = \sigma_Z\}$ developed in 1927.

Wolfgang Pauli (1927) Zur Quantenmechanik des magnetischen Elektrons *Zeitschrift für Physik* (43) 601-623

In 1843 Hamilton invents *quaternions* $\{1, i, j, k\}$. σ_μ related by *i*-factor: $\{\sigma_I = 1 = \sigma_0, i\sigma_B = i = i\sigma_X, i\sigma_C = j = i\sigma_Y, i\sigma_A = k = i\sigma_Z\}$.

Each Hamilton quaternion squares to *negative-1* ($i^2 = j^2 = k^2 = -1$) like imaginary number $i^2 = -1$. (They make up the Quaternion group.)

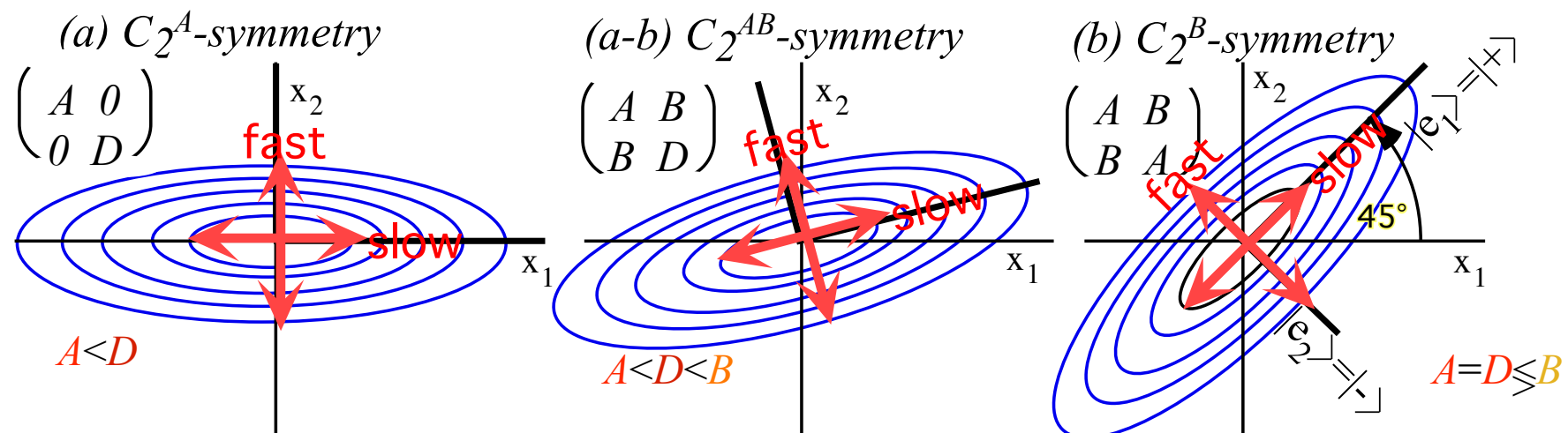

Fig. 3.4.1 Potentials for (a) C_2^A -asymmetric-diagonal, (ab) C_2^{AB} -mixed, (b) C_2^B -bilateral U(2)system.

ABCD Symmetry operator analysis and U(2) spinors

Decompose the Hamiltonian operator \mathbf{H} into four *ABCD symmetry operators*
 (Labeled to provide dynamic mnemonics as well as colorful analogies)

$$\begin{pmatrix} A & B-iC \\ B+iC & D \end{pmatrix} = A \begin{pmatrix} 1 & 0 \\ 0 & 0 \end{pmatrix} + B \begin{pmatrix} 0 & 1 \\ 1 & 0 \end{pmatrix} + C \begin{pmatrix} 0 & -i \\ i & 0 \end{pmatrix} + D \begin{pmatrix} 0 & 0 \\ 0 & 1 \end{pmatrix} = A\mathbf{e}_{11} + B\boldsymbol{\sigma}_B + C\boldsymbol{\sigma}_C + D\mathbf{e}_{22}$$

$$= \frac{A-D}{2} \begin{pmatrix} 1 & 0 \\ 0 & -1 \end{pmatrix} + B \begin{pmatrix} 0 & 1 \\ 1 & 0 \end{pmatrix} + C \begin{pmatrix} 0 & -i \\ i & 0 \end{pmatrix} + \frac{A+D}{2} \begin{pmatrix} 1 & 0 \\ 0 & 1 \end{pmatrix}$$

$$\mathbf{H} = \frac{A-D}{2} \boldsymbol{\sigma}_A + B \boldsymbol{\sigma}_B + C \boldsymbol{\sigma}_C + \frac{A+D}{2} \boldsymbol{\sigma}_0 \quad \dots\text{current-carrier...}$$

Symmetry archetypes: *A (Asymmetric-diagonal)* | *B (Bilateral-balanced)* | *C (Chiral-circular-complex-Coriolis-cyclotron-curly...)*

The $\{\boldsymbol{\sigma}_I, \boldsymbol{\sigma}_A, \boldsymbol{\sigma}_B, \boldsymbol{\sigma}_C\}$ are best known as *Pauli-spin operators* $\{\boldsymbol{\sigma}_I = \boldsymbol{\sigma}_0, \boldsymbol{\sigma}_B = \boldsymbol{\sigma}_X, \boldsymbol{\sigma}_C = \boldsymbol{\sigma}_Y, \boldsymbol{\sigma}_A = \boldsymbol{\sigma}_Z\}$ developed in 1927.

Wolfgang Pauli (1927) Zur Quantenmechanik des magnetischen Elektrons *Zeitschrift für Physik* (43) 601-623

In 1843 Hamilton invents *quaternions* $\{\mathbf{1}, \mathbf{i}, \mathbf{j}, \mathbf{k}\}$. $\boldsymbol{\sigma}_\mu$ related by *i*-factor: $\{\boldsymbol{\sigma}_I = \mathbf{1} = \boldsymbol{\sigma}_0, i\boldsymbol{\sigma}_B = \mathbf{i} = i\boldsymbol{\sigma}_X, i\boldsymbol{\sigma}_C = \mathbf{j} = i\boldsymbol{\sigma}_Y, i\boldsymbol{\sigma}_A = \mathbf{k} = i\boldsymbol{\sigma}_Z\}$.

Each Hamilton quaternion squares to *negative-1* ($\mathbf{i}^2 = \mathbf{j}^2 = \mathbf{k}^2 = -1$) like imaginary number $i^2 = -1$. (They make up the Quaternion group.)

Each Pauli $\boldsymbol{\sigma}_\mu$ squares to *positive-1* ($\boldsymbol{\sigma}_X^2 = \boldsymbol{\sigma}_Y^2 = \boldsymbol{\sigma}_Z^2 = +1$) (Each makes a cyclic C_2 group $C_2^A = \{\mathbf{1}, \boldsymbol{\sigma}_A\}$, $C_2^B = \{\mathbf{1}, \boldsymbol{\sigma}_B\}$, or $C_2^C = \{\mathbf{1}, \boldsymbol{\sigma}_C\}$.)

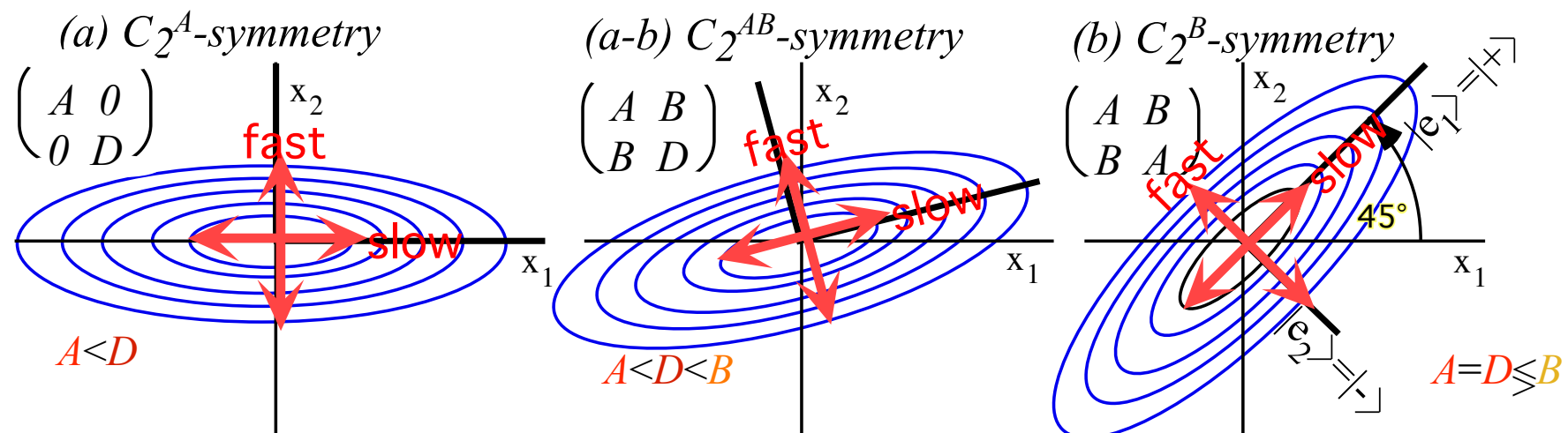

Fig. 3.4.1 Potentials for (a) C_2^A -asymmetric-diagonal, (ab) C_2^{AB} -mixed, (b) C_2^B -bilateral U(2)system.

*ANALOGY: 2-State Schrodinger: $i\hbar\partial_t|\Psi(t)\rangle = \mathbf{H}|\Psi(t)\rangle$ versus Classical 2D-HO: $\partial_t^2\mathbf{x} = -\mathbf{K}\cdot\mathbf{x}$
 Hamilton-Pauli spinor symmetry (σ -expansion in *ABCD*-Types) $\mathbf{H} = \omega_\mu \boldsymbol{\sigma}_\mu$*

➔ *Derive σ -exponential time evolution (or revolution) operator $\mathbf{U} = e^{-i\mathbf{H}t} = e^{-i\boldsymbol{\sigma}_\mu \omega_\mu t}$*

➔ *Spinor arithmetic like complex arithmetic*

Spinor vector algebra like complex vector algebra

Spinor exponentials like complex exponentials (“Crazy-Thing”-Theorem)

Geometry of evolution (or revolution) operator $\mathbf{U} = e^{-i\mathbf{H}t} = e^{-i\boldsymbol{\sigma}_\mu \omega_\mu t}$

The “mysterious” factors of 2 (or 1/2): 2D Spinor vs 3D Spin Vector space

2D Spinor vs 3D vector rotation

NMR Hamiltonian: 3D Spin Moment \mathbf{m} in \mathbf{B} field

OBJECTIVE: Evaluate and (*most important!*) *visualize* matrix-exponent solutions.

$$|\Psi(t)\rangle = e^{-i\mathbf{H}t}|\Psi(0)\rangle$$

Hamilton generalized Euler's expansion $e^{-i\omega t} = \cos \omega t - i \sin \omega t$ so matrix exponential becomes powerful.

$$e^{-i\mathbf{H}t} = e^{-i \begin{pmatrix} A & B-iC \\ B+iC & D \end{pmatrix} t} = e^{-i \frac{A-D}{2} \begin{pmatrix} 1 & 0 \\ 0 & -1 \end{pmatrix} t} e^{-iB \begin{pmatrix} 0 & 1 \\ 1 & 0 \end{pmatrix} t} e^{-iC \begin{pmatrix} 0 & -i \\ i & 0 \end{pmatrix} t} e^{-i \frac{A+D}{2} \begin{pmatrix} 1 & 0 \\ 0 & 1 \end{pmatrix} t}$$

$\sigma_A = \sigma_Z$ $\sigma_B = \sigma_X$ $\sigma_C = \sigma_Y$

$$= e^{-i\sigma_\varphi \varphi} e^{-i\omega_0 t} = e^{-i\vec{\sigma} \cdot \vec{\omega} t} e^{-i\omega_0 t} \text{ where: } \vec{\varphi} = \begin{pmatrix} \varphi_A \\ \varphi_B \\ \varphi_C \end{pmatrix} = \vec{\omega} \cdot t = \begin{pmatrix} \omega_A \\ \omega_B \\ \omega_C \end{pmatrix} \cdot t = \begin{pmatrix} \frac{A-D}{2} \\ B \\ C \end{pmatrix} \cdot t \text{ and: } \omega_0 = \frac{A+D}{2}$$

ABCD Time evolution operator

For constant A, B, C, and D

Symmetry relations make spinors $\sigma_X = \sigma_B$, $\sigma_Y = \sigma_C$, and $\sigma_Z = \sigma_A$ or quaternions $\mathbf{i} = -i\sigma_X$, $\mathbf{j} = -i\sigma_Y$, and $\mathbf{k} = -i\sigma_Z$ powerful.

Each σ_x squares to one (unit matrix $\mathbf{1} = \sigma_x \cdot \sigma_x$) and each quaternion squares to minus-one ($-\mathbf{1} = \mathbf{i} \cdot \mathbf{i} = \mathbf{j} \cdot \mathbf{j}$, etc.) just like $i = \sqrt{-1}$.

OBJECTIVE: Evaluate and (*most important!*) *visualize* matrix-exponent solutions.

$$|\Psi(t)\rangle = e^{-i\mathbf{H}t}|\Psi(0)\rangle$$

Hamilton generalized Euler's expansion $e^{-i\omega t} = \cos \omega t - i \sin \omega t$ so matrix exponential becomes powerful.

$$e^{-i\mathbf{H}t} = e^{-i \begin{pmatrix} A & B-iC \\ B+iC & D \end{pmatrix} t} = e^{-i \frac{A-D}{2} \begin{pmatrix} 1 & 0 \\ 0 & -1 \end{pmatrix} t} e^{-iB \begin{pmatrix} 0 & 1 \\ 1 & 0 \end{pmatrix} t} e^{-iC \begin{pmatrix} 0 & -i \\ i & 0 \end{pmatrix} t} e^{-i \frac{A+D}{2} \begin{pmatrix} 1 & 0 \\ 0 & 1 \end{pmatrix} t}$$

$\sigma_A = \sigma_Z$ $\sigma_B = \sigma_X$ $\sigma_C = \sigma_Y$

$$= e^{-i\sigma_\varphi \varphi} e^{-i\omega_0 t} = e^{-i\vec{\sigma} \cdot \vec{\omega} t} e^{-i\omega_0 t} \text{ where: } \vec{\varphi} = \begin{pmatrix} \varphi_A \\ \varphi_B \\ \varphi_C \end{pmatrix} = \vec{\omega} \cdot t = \begin{pmatrix} \omega_A \\ \omega_B \\ \omega_C \end{pmatrix} \cdot t = \begin{pmatrix} \frac{A-D}{2} \\ B \\ C \end{pmatrix} \cdot t \text{ and: } \omega_0 = \frac{A+D}{2}$$

ABCD Time evolution operator

For constant A, B, C, and D

Symmetry relations make spinors $\sigma_X = \sigma_B$, $\sigma_Y = \sigma_C$, and $\sigma_Z = \sigma_A$ or quaternions $\mathbf{i} = -i\sigma_X$, $\mathbf{j} = -i\sigma_Y$, and $\mathbf{k} = -i\sigma_Z$ powerful.

Each σ_x squares to one (unit matrix $\mathbf{1} = \sigma_x \cdot \sigma_x$) and each quaternion squares to minus-one ($-\mathbf{1} = \mathbf{i} \cdot \mathbf{i} = \mathbf{j} \cdot \mathbf{j}$, etc.) just like $i = \sqrt{-1}$.

This is true for spinor components based on *any* unit vector $\hat{\mathbf{a}} = (a_x, a_y, a_z)$ for which $\hat{\mathbf{a}} \cdot \hat{\mathbf{a}} = 1 = a_x^2 + a_y^2 + a_z^2$.

To see this just try it out on any $\hat{\mathbf{a}}$ -component: $\sigma_a = \sigma \cdot \hat{\mathbf{a}} = a_x \sigma_X + a_y \sigma_Y + a_z \sigma_Z$.

$$\begin{aligned} \sigma_a^2 &= (\sigma \cdot \hat{\mathbf{a}})(\sigma \cdot \hat{\mathbf{a}}) = (a_x \sigma_X + a_y \sigma_Y + a_z \sigma_Z)(a_x \sigma_X + a_y \sigma_Y + a_z \sigma_Z) \\ &= \begin{matrix} a_x \sigma_X a_x \sigma_X & + a_x \sigma_X a_y \sigma_Y & + a_x \sigma_X a_z \sigma_Z & a_x a_x \sigma_X \sigma_X & + a_x a_y \sigma_X \sigma_Y & + a_x a_z \sigma_X \sigma_Z \\ + a_y \sigma_Y a_x \sigma_X & + a_y \sigma_Y a_y \sigma_Y & + a_y \sigma_Y a_z \sigma_Z & + a_y a_x \sigma_Y \sigma_X & + a_y a_y \sigma_Y \sigma_Y & + a_y a_z \sigma_Y \sigma_Z \\ + a_z \sigma_Z a_x \sigma_X & + a_z \sigma_Z a_y \sigma_Y & + a_z \sigma_Z a_z \sigma_Z & + a_z a_x \sigma_Z \sigma_X & + a_z a_y \sigma_Z \sigma_Y & + a_z a_z \sigma_Z \sigma_Z \end{matrix} \end{aligned}$$

OBJECTIVE: Evaluate and (*most important!*) *visualize* matrix-exponent solutions.

$$|\Psi(t)\rangle = e^{-i\mathbf{H}t}|\Psi(0)\rangle$$

Hamilton generalized Euler's expansion $e^{-i\omega t} = \cos \omega t - i \sin \omega t$ so matrix exponential becomes powerful.

$$e^{-i\mathbf{H}t} = e^{-i \begin{pmatrix} A & B-iC \\ B+iC & D \end{pmatrix} t} = e^{-i \frac{A-D}{2} \begin{pmatrix} 1 & 0 \\ 0 & -1 \end{pmatrix} t} e^{-iB \begin{pmatrix} 0 & 1 \\ 1 & 0 \end{pmatrix} t} e^{-iC \begin{pmatrix} 0 & -i \\ i & 0 \end{pmatrix} t} e^{-i \frac{A+D}{2} \begin{pmatrix} 1 & 0 \\ 0 & 1 \end{pmatrix} t}$$

$\sigma_A = \sigma_Z$ $\sigma_B = \sigma_X$ $\sigma_C = \sigma_Y$

$$= e^{-i\sigma_\varphi \varphi} e^{-i\omega_0 t} = e^{-i\vec{\sigma} \cdot \vec{\omega} t} e^{-i\omega_0 t} \text{ where: } \vec{\varphi} = \begin{pmatrix} \varphi_A \\ \varphi_B \\ \varphi_C \end{pmatrix} = \vec{\omega} \cdot t = \begin{pmatrix} \omega_A \\ \omega_B \\ \omega_C \end{pmatrix} \cdot t = \begin{pmatrix} \frac{A-D}{2} \\ B \\ C \end{pmatrix} \cdot t \text{ and: } \omega_0 = \frac{A+D}{2}$$

ABCD Time evolution operator

For constant A, B, C, and D

Symmetry relations make spinors $\sigma_X = \sigma_B$, $\sigma_Y = \sigma_C$, and $\sigma_Z = \sigma_A$ or quaternions $\mathbf{i} = -i\sigma_X$, $\mathbf{j} = -i\sigma_Y$, and $\mathbf{k} = -i\sigma_Z$ powerful.

Each σ_x squares to one (unit matrix $\mathbf{1} = \sigma_x \cdot \sigma_x$) and each quaternion squares to minus-one ($-\mathbf{1} = \mathbf{i} \cdot \mathbf{i} = \mathbf{j} \cdot \mathbf{j}$, etc.) just like $i = \sqrt{-1}$.

This is true for spinor components based on *any* unit vector $\hat{\mathbf{a}} = (a_x, a_y, a_z)$ for which $\hat{\mathbf{a}} \cdot \hat{\mathbf{a}} = 1 = a_x^2 + a_y^2 + a_z^2$.

To see this just try it out on any $\hat{\mathbf{a}}$ -component: $\sigma_a = \sigma \cdot \hat{\mathbf{a}} = a_x \sigma_X + a_y \sigma_Y + a_z \sigma_Z$.

$$\sigma_a^2 = (\sigma \cdot \hat{\mathbf{a}})(\sigma \cdot \hat{\mathbf{a}}) = (a_x \sigma_X + a_y \sigma_Y + a_z \sigma_Z)(a_x \sigma_X + a_y \sigma_Y + a_z \sigma_Z)$$

$$= \begin{matrix} a_x^2 \sigma_X \sigma_X & + a_x a_y \sigma_X \sigma_Y & + a_x a_z \sigma_X \sigma_Z \\ + a_y \sigma_Y a_x \sigma_X & + a_y^2 \sigma_Y \sigma_Y & + a_y a_z \sigma_Y \sigma_Z \\ + a_z \sigma_Z a_x \sigma_X & + a_z \sigma_Z a_y \sigma_Y & + a_z^2 \sigma_Z \sigma_Z \end{matrix} = \begin{matrix} a_x^2 \mathbf{1} & + a_x a_y \sigma_X \sigma_Y & + a_x a_z \sigma_X \sigma_Z \\ - a_x a_y \sigma_X \sigma_Y & + a_y^2 \mathbf{1} & + a_y a_z \sigma_Y \sigma_Z \\ - a_x a_z \sigma_X \sigma_Z & - a_y a_z \sigma_Y \sigma_Z & + a_z^2 \mathbf{1} \end{matrix}$$

$$\begin{matrix} \sigma_Z \square \sigma_X \\ \begin{pmatrix} 1 & 0 \\ 0 & -1 \end{pmatrix} \begin{pmatrix} 0 & 1 \\ 1 & 0 \end{pmatrix} = \begin{pmatrix} 0 & 1 \\ -1 & 0 \end{pmatrix} = i \begin{pmatrix} 0 & -i \\ i & 0 \end{pmatrix} = i \sigma_Y \\ \sigma_X \square \sigma_Z \\ \begin{pmatrix} 0 & 1 \\ 1 & 0 \end{pmatrix} \begin{pmatrix} 1 & 0 \\ 0 & -1 \end{pmatrix} = \begin{pmatrix} 0 & -1 \\ 1 & 0 \end{pmatrix} = -i \begin{pmatrix} 0 & -i \\ i & 0 \end{pmatrix} = -i \sigma_Y \end{matrix}$$

To finish we need another symmetry property called *anti-commutation*: $\sigma_X \sigma_Y = -\sigma_Y \sigma_X$, $\sigma_X \sigma_Z = -\sigma_Z \sigma_X$, etc.

$$\sigma_a^2 = (\sigma \cdot \hat{\mathbf{a}})(\sigma \cdot \hat{\mathbf{a}}) = (a_x \sigma_X + a_y \sigma_Y + a_z \sigma_Z)(a_x \sigma_X + a_y \sigma_Y + a_z \sigma_Z)$$

$$= \begin{matrix} a_x^2 \mathbf{1} & + a_x a_y \sigma_X \sigma_Y & + a_x a_z \sigma_X \sigma_Z \\ - a_x a_y \sigma_X \sigma_Y & + a_y^2 \mathbf{1} & + a_y a_z \sigma_Y \sigma_Z \\ - a_x a_z \sigma_X \sigma_Z & - a_y a_z \sigma_Y \sigma_Z & + a_z^2 \mathbf{1} \end{matrix}$$

So: $\sigma_a^2 = \mathbf{1}$

OBJECTIVE: Evaluate and (*most important!*) *visualize* matrix-exponent solutions.

$$|\Psi(t)\rangle = e^{-i\mathbf{H}t}|\Psi(0)\rangle$$

Hamilton generalized Euler's expansion $e^{-i\omega t} = \cos \omega t - i \sin \omega t$ so matrix exponential becomes powerful.

$$e^{-i\mathbf{H}t} = e^{-i \begin{pmatrix} A & B-iC \\ B+iC & D \end{pmatrix} t} = e^{-i \frac{A-D}{2} \begin{pmatrix} 1 & 0 \\ 0 & -1 \end{pmatrix} t} e^{-iB \begin{pmatrix} 0 & 1 \\ 1 & 0 \end{pmatrix} t} e^{-iC \begin{pmatrix} 0 & -i \\ i & 0 \end{pmatrix} t} e^{-i \frac{A+D}{2} \begin{pmatrix} 1 & 0 \\ 0 & 1 \end{pmatrix} t}$$

$\sigma_A = \sigma_Z$ $\sigma_B = \sigma_X$ $\sigma_C = \sigma_Y$

$$= e^{-i\sigma_\varphi \varphi} e^{-i\omega_0 t} = e^{-i\vec{\sigma} \cdot \vec{\omega} t} e^{-i\omega_0 t} \text{ where: } \vec{\varphi} = \begin{pmatrix} \varphi_A \\ \varphi_B \\ \varphi_C \end{pmatrix} = \vec{\omega} \cdot t = \begin{pmatrix} \omega_A \\ \omega_B \\ \omega_C \end{pmatrix} \cdot t = \begin{pmatrix} \frac{A-D}{2} \\ B \\ C \end{pmatrix} \cdot t \text{ and: } \omega_0 = \frac{A+D}{2}$$

ABCD Time evolution operator

For constant A, B, C, and D

Symmetry relations make spinors $\sigma_X = \sigma_B$, $\sigma_Y = \sigma_C$, and $\sigma_Z = \sigma_A$ or quaternions $\mathbf{i} = -i\sigma_X$, $\mathbf{j} = -i\sigma_Y$, and $\mathbf{k} = -i\sigma_Z$ powerful.

Each σ_x squares to one (unit matrix $\mathbf{1} = \sigma_x \cdot \sigma_x$) and each quaternion squares to minus-one ($-\mathbf{1} = \mathbf{i} \cdot \mathbf{i} = \mathbf{j} \cdot \mathbf{j}$, etc.) just like $i = \sqrt{-1}$.

This is true for spinor components based on *any* unit vector $\hat{\mathbf{a}} = (a_x, a_y, a_z)$ for which $\hat{\mathbf{a}} \cdot \hat{\mathbf{a}} = 1 = a_x^2 + a_y^2 + a_z^2$.

To see this just try it out on any $\hat{\mathbf{a}}$ -component: $\sigma_a = \sigma \cdot \hat{\mathbf{a}} = a_x \sigma_X + a_y \sigma_Y + a_z \sigma_Z$.

$$\sigma_a^2 = (\sigma \cdot \hat{\mathbf{a}})(\sigma \cdot \hat{\mathbf{a}}) = (a_x \sigma_X + a_y \sigma_Y + a_z \sigma_Z)(a_x \sigma_X + a_y \sigma_Y + a_z \sigma_Z)$$

$$= a_x^2 \sigma_X \sigma_X + a_x a_y \sigma_X \sigma_Y + a_x a_z \sigma_X \sigma_Z + a_y a_x \sigma_Y \sigma_X + a_y^2 \sigma_Y \sigma_Y + a_y a_z \sigma_Y \sigma_Z + a_z a_x \sigma_Z \sigma_X + a_z a_y \sigma_Z \sigma_Y + a_z^2 \sigma_Z \sigma_Z$$

$$= a_x^2 \mathbf{1} + a_y^2 \mathbf{1} + a_z^2 \mathbf{1} = (a_x^2 + a_y^2 + a_z^2) \mathbf{1} = \mathbf{1}$$

$\sigma_Z \square \sigma_X = \begin{pmatrix} 1 & 0 \\ 0 & -1 \end{pmatrix} \begin{pmatrix} 0 & 1 \\ 1 & 0 \end{pmatrix} = \begin{pmatrix} 0 & 1 \\ -1 & 0 \end{pmatrix} = i \begin{pmatrix} 0 & -i \\ i & 0 \end{pmatrix} = i \sigma_Y$
 $\sigma_X \square \sigma_Z = \begin{pmatrix} 0 & 1 \\ 1 & 0 \end{pmatrix} \begin{pmatrix} 1 & 0 \\ 0 & -1 \end{pmatrix} = \begin{pmatrix} 0 & -1 \\ 1 & 0 \end{pmatrix} = -i \begin{pmatrix} 0 & -i \\ i & 0 \end{pmatrix} = -i \sigma_Y$

To finish we need another symmetry property called *anti-commutation*: $\sigma_X \sigma_Y = -\sigma_Y \sigma_X$, $\sigma_X \sigma_Z = -\sigma_Z \sigma_X$, etc.

$$\sigma_a^2 = (\sigma \cdot \hat{\mathbf{a}})(\sigma \cdot \hat{\mathbf{a}}) = (a_x \sigma_X + a_y \sigma_Y + a_z \sigma_Z)(a_x \sigma_X + a_y \sigma_Y + a_z \sigma_Z)$$

$$= a_x^2 \mathbf{1} + \cancel{a_x a_y \sigma_X \sigma_Y} + \cancel{a_x a_z \sigma_X \sigma_Z} + \cancel{-a_x a_y \sigma_Y \sigma_X} + a_y^2 \mathbf{1} + \cancel{a_y a_z \sigma_Y \sigma_Z} + \cancel{-a_x a_z \sigma_X \sigma_Z} + \cancel{-a_y a_z \sigma_Y \sigma_Z} + a_z^2 \mathbf{1}$$

$$= (a_x^2 + a_y^2 + a_z^2) \mathbf{1} = \mathbf{1}$$

So: $\sigma_a^2 = \mathbf{1}$

*ANALOGY: 2-State Schrodinger: $i\hbar\partial_t|\Psi(t)\rangle = \mathbf{H}|\Psi(t)\rangle$ versus Classical 2D-HO: $\partial_t^2\mathbf{x} = -\mathbf{K}\cdot\mathbf{x}$
 Hamilton-Pauli spinor symmetry (σ -expansion in *ABCD*-Types) $\mathbf{H} = \omega_\mu \boldsymbol{\sigma}_\mu$*

➔ *Derive σ -exponential time evolution (or revolution) operator $\mathbf{U} = e^{-i\mathbf{H}t} = e^{-i\boldsymbol{\sigma}_\mu \omega_\mu t}$*

Spinor arithmetic like complex arithmetic

➔ *Spinor vector algebra like complex vector algebra*

Spinor exponentials like complex exponentials (“Crazy-Thing”-Theorem)

Geometry of evolution (or revolution) operator $\mathbf{U} = e^{-i\mathbf{H}t} = e^{-i\boldsymbol{\sigma}_\mu \omega_\mu t}$

The “mysterious” factors of 2 (or 1/2): 2D Spinor vs 3D Spin Vector space

2D Spinor vs 3D vector rotation

NMR Hamiltonian: 3D Spin Moment \mathbf{m} in \mathbf{B} field

OBJECTIVE: Evaluate and (*most important!*) *visualize* matrix-exponent solutions.

$$|\Psi(t)\rangle = e^{-i\mathbf{H}t}|\Psi(0)\rangle$$

Hamilton generalized Euler's expansion $e^{-i\omega t} = \cos \omega t - i \sin \omega t$ so matrix exponential becomes powerful.

$$e^{-i\mathbf{H}t} = e^{-i \begin{pmatrix} A & B-iC \\ B+iC & D \end{pmatrix} t} = e^{-i \frac{A-D}{2} \begin{pmatrix} 1 & 0 \\ 0 & -1 \end{pmatrix} t} e^{-iB \begin{pmatrix} 0 & 1 \\ 1 & 0 \end{pmatrix} t} e^{-iC \begin{pmatrix} 0 & -i \\ i & 0 \end{pmatrix} t} e^{-i \frac{A+D}{2} \begin{pmatrix} 1 & 0 \\ 0 & 1 \end{pmatrix} t}$$

$\sigma_A = \sigma_Z$ $\sigma_B = \sigma_X$ $\sigma_C = \sigma_Y$

$$= e^{-i\sigma_\varphi \varphi} e^{-i\omega_0 t} = e^{-i\vec{\sigma} \cdot \vec{\omega} t} e^{-i\omega_0 t} \text{ where: } \vec{\varphi} = \begin{pmatrix} \varphi_A \\ \varphi_B \\ \varphi_C \end{pmatrix} = \vec{\omega} \cdot t = \begin{pmatrix} \omega_A \\ \omega_B \\ \omega_C \end{pmatrix} \cdot t = \begin{pmatrix} \frac{A-D}{2} \\ B \\ C \end{pmatrix} \cdot t \text{ and: } \omega_0 = \frac{A+D}{2}$$

ABCD Time evolution operator

For constant A, B, C, and D

Symmetry relations make spinors $\sigma_X = \sigma_B$, $\sigma_Y = \sigma_C$, and $\sigma_Z = \sigma_A$ or quaternions $\mathbf{i} = -i\sigma_X$, $\mathbf{j} = -i\sigma_Y$, and $\mathbf{k} = -i\sigma_Z$ powerful.

σ -products do dot \cdot and cross \times products by symmetries: $\sigma_X \sigma_Y = i\sigma_Z = -\sigma_Y \sigma_X$, $\sigma_Z \sigma_X = i\sigma_Y = -\sigma_X \sigma_Z$, $\sigma_Y \sigma_Z = i\sigma_X = -\sigma_Z \sigma_Y$

OBJECTIVE: Evaluate and (*most important!*) *visualize* matrix-exponent solutions.

$$|\Psi(t)\rangle = e^{-i\mathbf{H}t}|\Psi(0)\rangle$$

Hamilton generalized Euler's expansion $e^{-i\omega t} = \cos \omega t - i \sin \omega t$ so matrix exponential becomes powerful.

$$e^{-i\mathbf{H}t} = e^{-i \begin{pmatrix} A & B-iC \\ B+iC & D \end{pmatrix} t} = e^{-i \frac{A-D}{2} \begin{pmatrix} 1 & 0 \\ 0 & -1 \end{pmatrix} t} e^{-iB \begin{pmatrix} 0 & 1 \\ 1 & 0 \end{pmatrix} t} e^{-iC \begin{pmatrix} 0 & -i \\ i & 0 \end{pmatrix} t} e^{-i \frac{A+D}{2} \begin{pmatrix} 1 & 0 \\ 0 & 1 \end{pmatrix} t}$$

$\sigma_A = \sigma_Z$ $\sigma_B = \sigma_X$ $\sigma_C = \sigma_Y$

$$= e^{-i\sigma_\varphi \varphi} e^{-i\omega_0 t} = e^{-i\vec{\sigma} \cdot \vec{\omega} t} e^{-i\omega_0 t} \text{ where: } \vec{\varphi} = \begin{pmatrix} \varphi_A \\ \varphi_B \\ \varphi_C \end{pmatrix} = \vec{\omega} \cdot t = \begin{pmatrix} \omega_A \\ \omega_B \\ \omega_C \end{pmatrix} \cdot t = \begin{pmatrix} \frac{A-D}{2} \\ B \\ C \end{pmatrix} \cdot t \text{ and: } \omega_0 = \frac{A+D}{2}$$

ABCD Time evolution operator

For constant A, B, C, and D

Symmetry relations make spinors $\sigma_X = \sigma_B$, $\sigma_Y = \sigma_C$, and $\sigma_Z = \sigma_A$ or quaternions $\mathbf{i} = -i\sigma_X$, $\mathbf{j} = -i\sigma_Y$, and $\mathbf{k} = -i\sigma_Z$ powerful.

σ -products do dot \cdot and cross \times products by symmetries: $\sigma_X \sigma_Y = i\sigma_Z = -\sigma_Y \sigma_X$, $\sigma_Z \sigma_X = i\sigma_Y = -\sigma_X \sigma_Z$, $\sigma_Y \sigma_Z = i\sigma_X = -\sigma_Z \sigma_Y$

$$\sigma_a \sigma_b = (\sigma \cdot \mathbf{a})(\sigma \cdot \mathbf{b}) = (a_X \sigma_X + a_Y \sigma_Y + a_Z \sigma_Z)(b_X \sigma_X + b_Y \sigma_Y + b_Z \sigma_Z)$$

$$= \begin{matrix} a_X b_X \mathbf{1} & +a_X b_Y \sigma_X \sigma_Y & -a_X b_Z \sigma_Z \sigma_X & +i(a_Y b_Z - a_Z b_Y) \sigma_X \\ -a_Y b_X \sigma_X \sigma_Y & +a_Y b_Y \mathbf{1} & +a_Y b_Z \sigma_Y \sigma_Z & +i(a_Z b_X - a_X b_Z) \sigma_Y \\ +a_Z b_X \sigma_Z \sigma_X & -a_Z b_Y \sigma_Y \sigma_Z & +a_Z b_Z \mathbf{1} & +i(a_X b_Y - a_Y b_X) \sigma_Z \end{matrix}$$

$$\begin{matrix} \sigma_Z \square \sigma_X \\ \begin{pmatrix} 1 & 0 \\ 0 & -1 \end{pmatrix} \begin{pmatrix} 0 & 1 \\ 1 & 0 \end{pmatrix} = \begin{pmatrix} 0 & 1 \\ -1 & 0 \end{pmatrix} = i \begin{pmatrix} 0 & -i \\ i & 0 \end{pmatrix} = i\sigma_Y \\ \sigma_X \square \sigma_Z \\ \begin{pmatrix} 0 & 1 \\ 1 & 0 \end{pmatrix} \begin{pmatrix} 1 & 0 \\ 0 & -1 \end{pmatrix} = \begin{pmatrix} 0 & -1 \\ 1 & 0 \end{pmatrix} = -i \begin{pmatrix} 0 & -i \\ i & 0 \end{pmatrix} = -i\sigma_Y \end{matrix}$$

OBJECTIVE: Evaluate and (*most important!*) *visualize* matrix-exponent solutions.

$$|\Psi(t)\rangle = e^{-i\mathbf{H}t}|\Psi(0)\rangle$$

Hamilton generalized Euler's expansion $e^{-i\omega t} = \cos \omega t - i \sin \omega t$ so matrix exponential becomes powerful.

$$e^{-i\mathbf{H}t} = e^{-i \begin{pmatrix} A & B-iC \\ B+iC & D \end{pmatrix} t} = e^{-i \frac{A-D}{2} \begin{pmatrix} 1 & 0 \\ 0 & -1 \end{pmatrix} t} e^{-iB \begin{pmatrix} 0 & 1 \\ 1 & 0 \end{pmatrix} t} e^{-iC \begin{pmatrix} 0 & -i \\ i & 0 \end{pmatrix} t} e^{-i \frac{A+D}{2} \begin{pmatrix} 1 & 0 \\ 0 & 1 \end{pmatrix} t}$$

$\sigma_A = \sigma_Z$ $\sigma_B = \sigma_X$ $\sigma_C = \sigma_Y$

$$= e^{-i\sigma_\varphi \varphi} e^{-i\omega_0 t} = e^{-i\vec{\sigma} \cdot \vec{\omega} t} e^{-i\omega_0 t} \text{ where: } \vec{\varphi} = \begin{pmatrix} \varphi_A \\ \varphi_B \\ \varphi_C \end{pmatrix} = \vec{\omega} \cdot t = \begin{pmatrix} \omega_A \\ \omega_B \\ \omega_C \end{pmatrix} \cdot t = \begin{pmatrix} \frac{A-D}{2} \\ B \\ C \end{pmatrix} \cdot t \text{ and: } \omega_0 = \frac{A+D}{2}$$

ABCD Time evolution operator

For constant A, B, C, and D

Symmetry relations make spinors $\sigma_X = \sigma_B$, $\sigma_Y = \sigma_C$, and $\sigma_Z = \sigma_A$ or quaternions $\mathbf{i} = -i\sigma_X$, $\mathbf{j} = -i\sigma_Y$, and $\mathbf{k} = -i\sigma_Z$ powerful.

σ -products do dot \bullet and cross \times products by symmetries: $\sigma_X \sigma_Y = i\sigma_Z = -\sigma_Y \sigma_X$, $\sigma_Z \sigma_X = i\sigma_Y = -\sigma_X \sigma_Z$, $\sigma_Y \sigma_Z = i\sigma_X = -\sigma_Z \sigma_Y$

$$\begin{aligned} \sigma_a \sigma_b &= (\sigma \bullet \mathbf{a})(\sigma \bullet \mathbf{b}) = (a_X \sigma_X + a_Y \sigma_Y + a_Z \sigma_Z)(b_X \sigma_X + b_Y \sigma_Y + b_Z \sigma_Z) \\ &= \begin{matrix} a_X b_X \mathbf{1} & + a_X b_Y \sigma_X \sigma_Y & - a_X b_Z \sigma_Z \sigma_X & + i(a_Y b_Z - a_Z b_Y) \sigma_X \\ - a_Y b_X \sigma_X \sigma_Y & + a_Y b_Y \mathbf{1} & + a_Y b_Z \sigma_Y \sigma_Z & + i(a_Z b_X - a_X b_Z) \sigma_Y \\ + a_Z b_X \sigma_Z \sigma_X & - a_Z b_Y \sigma_Y \sigma_Z & + a_Z b_Z \mathbf{1} & + i(a_X b_Y - a_Y b_X) \sigma_Z \end{matrix} \\ &= (a_X b_X + a_Y b_Y + a_Z b_Z) \mathbf{1} + i(a_Y b_Z - a_Z b_Y) \sigma_X + i(a_Z b_X - a_X b_Z) \sigma_Y + i(a_X b_Y - a_Y b_X) \sigma_Z \end{aligned}$$

Write the product in Gibbs notation. (This is where Gibbs got his $\{\mathbf{i}, \mathbf{j}, \mathbf{k}\}$ notation!)

$$\sigma_a \sigma_b = (\sigma \bullet \mathbf{a})(\sigma \bullet \mathbf{b}) = (\mathbf{a} \bullet \mathbf{b}) \mathbf{1} + i(\mathbf{a} \times \mathbf{b}) \bullet \sigma$$

$$\begin{aligned} \sigma_Z \square \sigma_X &= \begin{pmatrix} 1 & 0 \\ 0 & -1 \end{pmatrix} \begin{pmatrix} 0 & 1 \\ 1 & 0 \end{pmatrix} = \begin{pmatrix} 0 & 1 \\ -1 & 0 \end{pmatrix} = i \begin{pmatrix} 0 & -i \\ i & 0 \end{pmatrix} = i\sigma_Y \\ \sigma_X \square \sigma_Z &= \begin{pmatrix} 0 & 1 \\ 1 & 0 \end{pmatrix} \begin{pmatrix} 1 & 0 \\ 0 & -1 \end{pmatrix} = \begin{pmatrix} 0 & -1 \\ 1 & 0 \end{pmatrix} = -i \begin{pmatrix} 0 & -i \\ i & 0 \end{pmatrix} = -i\sigma_Y \end{aligned}$$

OBJECTIVE: Evaluate and (*most important!*) *visualize* matrix-exponent solutions.

$$|\Psi(t)\rangle = e^{-i\mathbf{H}t}|\Psi(0)\rangle$$

Hamilton generalized Euler's expansion $e^{-i\omega t} = \cos \omega t - i \sin \omega t$ so matrix exponential becomes powerful.

$$e^{-i\mathbf{H}t} = e^{-i \begin{pmatrix} A & B-iC \\ B+iC & D \end{pmatrix} t} = e^{-i \frac{A-D}{2} \begin{pmatrix} 1 & 0 \\ 0 & -1 \end{pmatrix} t - iB \begin{pmatrix} 0 & 1 \\ 1 & 0 \end{pmatrix} t - iC \begin{pmatrix} 0 & -i \\ i & 0 \end{pmatrix} t - i \frac{A+D}{2} \begin{pmatrix} 1 & 0 \\ 0 & 1 \end{pmatrix} t}$$

$\sigma_A = \sigma_Z$ $\sigma_B = \sigma_X$ $\sigma_C = \sigma_Y$

$$= e^{-i\sigma_\varphi \varphi} e^{-i\omega_0 t} = e^{-i\vec{\sigma} \cdot \vec{\omega} t} e^{-i\omega_0 t} \text{ where: } \vec{\varphi} = \begin{pmatrix} \varphi_A \\ \varphi_B \\ \varphi_C \end{pmatrix} = \vec{\omega} \cdot t = \begin{pmatrix} \omega_A \\ \omega_B \\ \omega_C \end{pmatrix} \cdot t = \begin{pmatrix} \frac{A-D}{2} \\ B \\ C \end{pmatrix} \cdot t \text{ and: } \omega_0 = \frac{A+D}{2}$$

ABCD Time evolution operator

For constant A, B, C, and D

Symmetry relations make spinors $\sigma_X = \sigma_B$, $\sigma_Y = \sigma_C$, and $\sigma_Z = \sigma_A$ or quaternions $\mathbf{i} = -i\sigma_X$, $\mathbf{j} = -i\sigma_Y$, and $\mathbf{k} = -i\sigma_Z$ powerful.

σ -products do dot \bullet and cross \times products by symmetries: $\sigma_X \sigma_Y = i\sigma_Z = -\sigma_Y \sigma_X$, $\sigma_Z \sigma_X = i\sigma_Y = -\sigma_X \sigma_Z$, $\sigma_Y \sigma_Z = i\sigma_X = -\sigma_Z \sigma_Y$

$$\begin{aligned} \sigma_a \sigma_b &= (\sigma \bullet \mathbf{a})(\sigma \bullet \mathbf{b}) = (a_X \sigma_X + a_Y \sigma_Y + a_Z \sigma_Z)(b_X \sigma_X + b_Y \sigma_Y + b_Z \sigma_Z) \\ &= a_X b_X \mathbf{1} + a_X b_Y \sigma_X \sigma_Y - a_X b_Z \sigma_Z \sigma_X + i(a_Y b_Z - a_Z b_Y) \sigma_X \\ &\quad - a_Y b_X \sigma_X \sigma_Y + a_Y b_Y \mathbf{1} + a_Y b_Z \sigma_Y \sigma_Z + i(a_Z b_X - a_X b_Z) \sigma_Y \\ &\quad + a_Z b_X \sigma_Z \sigma_X - a_Z b_Y \sigma_Y \sigma_Z + a_Z b_Z \mathbf{1} + i(a_X b_Y - a_Y b_X) \sigma_Z \end{aligned}$$

Write the product in Gibbs notation. (This is where Gibbs got his $\{\mathbf{i}, \mathbf{j}, \mathbf{k}\}$ notation!)

$$\sigma_a \sigma_b = (\sigma \bullet \mathbf{a})(\sigma \bullet \mathbf{b}) = (\mathbf{a} \bullet \mathbf{b}) \mathbf{1} + i(\mathbf{a} \times \mathbf{b}) \bullet \sigma$$

$$\begin{aligned} \sigma_Z \square \sigma_X &= \begin{pmatrix} 1 & 0 \\ 0 & -1 \end{pmatrix} \begin{pmatrix} 0 & 1 \\ 1 & 0 \end{pmatrix} = \begin{pmatrix} 0 & 1 \\ -1 & 0 \end{pmatrix} = i \begin{pmatrix} 0 & -i \\ i & 0 \end{pmatrix} = i\sigma_Y \\ \sigma_X \square \sigma_Z &= \begin{pmatrix} 0 & 1 \\ 1 & 0 \end{pmatrix} \begin{pmatrix} 1 & 0 \\ 0 & -1 \end{pmatrix} = \begin{pmatrix} 0 & -1 \\ 1 & 0 \end{pmatrix} = -i \begin{pmatrix} 0 & -i \\ i & 0 \end{pmatrix} = -i\sigma_Y \end{aligned}$$

(Recall (1.10.29). in complex variable unit.)

$$\begin{aligned} A^* B &= (A_X + iA_Y)^*(B_X + iB_Y) = (A_X - iA_Y)(B_X + iB_Y) \\ &= (A_X B_X + A_Y B_Y) + i(A_X B_Y - A_Y B_X) = (\mathbf{A} \bullet \mathbf{B}) + i(\mathbf{A} \times \mathbf{B})_Z \end{aligned}$$

*ANALOGY: 2-State Schrodinger: $i\hbar\partial_t|\Psi(t)\rangle = \mathbf{H}|\Psi(t)\rangle$ versus Classical 2D-HO: $\partial_t^2\mathbf{x} = -\mathbf{K}\cdot\mathbf{x}$
Hamilton-Pauli spinor symmetry (σ -expansion in *ABCD*-Types) $\mathbf{H} = \omega_\mu \boldsymbol{\sigma}_\mu$*

➔ *Derive σ -exponential time evolution (or revolution) operator $\mathbf{U} = e^{-i\mathbf{H}t} = e^{-i\boldsymbol{\sigma}_\mu \omega_\mu t}$*

Spinor arithmetic like complex arithmetic

Spinor vector algebra like complex vector algebra

➔ *Spinor exponentials like complex exponentials (“Crazy-Thing”-Theorem)*

Geometry of evolution (or revolution) operator $\mathbf{U} = e^{-i\mathbf{H}t} = e^{-i\boldsymbol{\sigma}_\mu \omega_\mu t}$

The “mysterious” factors of 2 (or 1/2): 2D Spinor vs 3D Spin Vector space

2D Spinor vs 3D vector rotation

NMR Hamiltonian: 3D Spin Moment \mathbf{m} in \mathbf{B} field

OBJECTIVE: Evaluate and (*most important!*) *visualize* matrix-exponent solutions.

$$|\Psi(t)\rangle = e^{-i\mathbf{H}t}|\Psi(0)\rangle$$

Hamilton generalized Euler's expansion $e^{-i\omega t} = \cos \omega t - i \sin \omega t$ so matrix exponential becomes powerful.

$$e^{-i\mathbf{H}t} = e^{-i \begin{pmatrix} A & B-iC \\ B+iC & D \end{pmatrix} t} = e^{-i \frac{A-D}{2} \begin{pmatrix} 1 & 0 \\ 0 & -1 \end{pmatrix} t} e^{-iB \begin{pmatrix} 0 & 1 \\ 1 & 0 \end{pmatrix} t} e^{-iC \begin{pmatrix} 0 & -i \\ i & 0 \end{pmatrix} t} e^{-i \frac{A+D}{2} \begin{pmatrix} 1 & 0 \\ 0 & 1 \end{pmatrix} t}$$

$\sigma_A = \sigma_Z$ $\sigma_B = \sigma_X$ $\sigma_C = \sigma_Y$

$$= e^{-i\sigma_\varphi \varphi} e^{-i\omega_0 t} = e^{-i\vec{\sigma} \cdot \vec{\omega} t} e^{-i\omega_0 t} \text{ where: } \vec{\varphi} = \begin{pmatrix} \varphi_A \\ \varphi_B \\ \varphi_C \end{pmatrix} = \vec{\omega} \cdot t = \begin{pmatrix} \omega_A \\ \omega_B \\ \omega_C \end{pmatrix} \cdot t = \begin{pmatrix} \frac{A-D}{2} \\ B \\ C \end{pmatrix} \cdot t \text{ and: } \omega_0 = \frac{A+D}{2}$$

ABCD Time evolution operator

For constant A, B, C, and D

Symmetry relations make spinors $\sigma_X = \sigma_B$, $\sigma_Y = \sigma_C$, and $\sigma_Z = \sigma_A$ or quaternions $\mathbf{i} = -i\sigma_X$, $\mathbf{j} = -i\sigma_Y$, and $\mathbf{k} = -i\sigma_Z$ powerful.

Hamilton is able to generalize Euler's complex rotation operators $e^{+i\varphi}$ and $e^{-i\varphi}$. (Recall (1.10.17).)

$$e^{-i\varphi} = 1 + (-i\varphi) + \frac{1}{2!}(-i\varphi)^2 + \frac{1}{3!}(-i\varphi)^3 + \frac{1}{4!}(-i\varphi)^4 \dots = \begin{bmatrix} 1 & -\frac{1}{2!}\varphi^2 & +\frac{1}{4!}\varphi^4 \dots \\ -i(\varphi & +\frac{1}{3!}\varphi^3 & \dots) \end{bmatrix} = \begin{bmatrix} [\cos \varphi] \\ -i(\sin \varphi) \end{bmatrix}$$

OBJECTIVE: Evaluate and (*most important!*) *visualize* matrix-exponent solutions.

$$|\Psi(t)\rangle = e^{-i\mathbf{H}t}|\Psi(0)\rangle$$

Hamilton generalized Euler's expansion $e^{-i\omega t} = \cos \omega t - i \sin \omega t$ so matrix exponential becomes powerful.

$$e^{-i\mathbf{H}t} = e^{-i \begin{pmatrix} A & B-iC \\ B+iC & D \end{pmatrix} t} = e^{-i \frac{A-D}{2} \begin{pmatrix} 1 & 0 \\ 0 & -1 \end{pmatrix} t} e^{-iB \begin{pmatrix} 0 & 1 \\ 1 & 0 \end{pmatrix} t} e^{-iC \begin{pmatrix} 0 & -i \\ i & 0 \end{pmatrix} t} e^{-i \frac{A+D}{2} \begin{pmatrix} 1 & 0 \\ 0 & 1 \end{pmatrix} t}$$

$\sigma_A = \sigma_Z$ $\sigma_B = \sigma_X$ $\sigma_C = \sigma_Y$

$$= e^{-i\sigma_\varphi \varphi} e^{-i\omega_0 t} = e^{-i\vec{\sigma} \cdot \vec{\omega} t} e^{-i\omega_0 t} \text{ where: } \vec{\varphi} = \begin{pmatrix} \varphi_A \\ \varphi_B \\ \varphi_C \end{pmatrix} = \vec{\omega} \cdot t = \begin{pmatrix} \omega_A \\ \omega_B \\ \omega_C \end{pmatrix} \cdot t = \begin{pmatrix} \frac{A-D}{2} \\ B \\ C \end{pmatrix} \cdot t \text{ and: } \omega_0 = \frac{A+D}{2}$$

ABCD Time evolution operator

For constant A, B, C, and D

Symmetry relations make spinors $\sigma_X = \sigma_B$, $\sigma_Y = \sigma_C$, and $\sigma_Z = \sigma_A$ or quaternions $\mathbf{i} = -i\sigma_X$, $\mathbf{j} = -i\sigma_Y$, and $\mathbf{k} = -i\sigma_Z$ powerful.

Hamilton is able to generalize Euler's complex rotation operators $e^{+i\varphi}$ and $e^{-i\varphi}$. (Recall (1.10.17).)

$$e^{-i\varphi} = 1 + (-i\varphi) + \frac{1}{2!}(-i\varphi)^2 + \frac{1}{3!}(-i\varphi)^3 + \frac{1}{4!}(-i\varphi)^4 \dots = [1 - \frac{1}{2!}\varphi^2 + \frac{1}{4!}\varphi^4 \dots] = [\cos \varphi]$$

Note even powers of $(-i)$ are ± 1
and odd powers of $(-i)$ are $\pm i$:

$$(-i)^0 = +1, \quad (-i)^1 = -i, \quad (-i)^2 = -1, \quad (-i)^3 = +i, \quad (-i)^4 = +1, \quad (-i)^5 = -i, \text{ etc.}$$

OBJECTIVE: Evaluate and (*most important!*) *visualize* matrix-exponent solutions.

$$|\Psi(t)\rangle = e^{-i\mathbf{H}t}|\Psi(0)\rangle$$

Hamilton generalized Euler's expansion $e^{-i\omega t} = \cos \omega t - i \sin \omega t$ so matrix exponential becomes powerful.

$$e^{-i\mathbf{H}t} = e^{-i \begin{pmatrix} A & B-iC \\ B+iC & D \end{pmatrix} t} = e^{-i \frac{A-D}{2} \begin{pmatrix} 1 & 0 \\ 0 & -1 \end{pmatrix} t} e^{-iB \begin{pmatrix} 0 & 1 \\ 1 & 0 \end{pmatrix} t} e^{-iC \begin{pmatrix} 0 & -i \\ i & 0 \end{pmatrix} t} e^{-i \frac{A+D}{2} \begin{pmatrix} 1 & 0 \\ 0 & 1 \end{pmatrix} t}$$

$\sigma_A = \sigma_Z$ $\sigma_B = \sigma_X$ $\sigma_C = \sigma_Y$

$$= e^{-i\sigma_\varphi \varphi} e^{-i\omega_0 t} = e^{-i\vec{\sigma} \cdot \vec{\omega} t} e^{-i\omega_0 t} \text{ where: } \vec{\varphi} = \begin{pmatrix} \varphi_A \\ \varphi_B \\ \varphi_C \end{pmatrix} = \vec{\omega} \cdot t = \begin{pmatrix} \omega_A \\ \omega_B \\ \omega_C \end{pmatrix} \cdot t = \begin{pmatrix} \frac{A-D}{2} \\ B \\ C \end{pmatrix} \cdot t \text{ and: } \omega_0 = \frac{A+D}{2}$$

ABCD Time evolution operator

For constant A, B, C, and D

Symmetry relations make spinors $\sigma_X = \sigma_B$, $\sigma_Y = \sigma_C$, and $\sigma_Z = \sigma_A$ or quaternions $\mathbf{i} = -i\sigma_X$, $\mathbf{j} = -i\sigma_Y$, and $\mathbf{k} = -i\sigma_Z$ powerful.

Hamilton is able to generalize Euler's complex rotation operators $e^{+i\varphi}$ and $e^{-i\varphi}$. (Recall (1.10.17).)

$$e^{-i\varphi} = 1 + (-i\varphi) + \frac{1}{2!}(-i\varphi)^2 + \frac{1}{3!}(-i\varphi)^3 + \frac{1}{4!}(-i\varphi)^4 \dots = [1 - \frac{1}{2!}\varphi^2 + \frac{1}{4!}\varphi^4 \dots] = [\cos \varphi]$$

Note even powers of $(-i)$ are ± 1

and odd powers of $(-i)$ are $\pm i$:

$$-i(\varphi - \frac{1}{3!}\varphi^3 + \dots) = -i(\sin \varphi)$$

$$(-i)^0 = +1, (-i)^1 = -i, (-i)^2 = -1, (-i)^3 = +i, (-i)^4 = +1, (-i)^5 = -i, \text{ etc.}$$

Hamilton replaces $(-i)$ with $-i\sigma_\varphi$ in the $e^{-i\varphi}$ power series above to get a sequence of terms just like it.

$$(-i\sigma_\varphi)^0 = +1, (-i\sigma_\varphi)^1 = -i\sigma_\varphi, (-i\sigma_\varphi)^2 = -1, (-i\sigma_\varphi)^3 = +i\sigma_\varphi, (-i\sigma_\varphi)^4 = +1, (-i\sigma_\varphi)^5 = -i\sigma_\varphi, \text{ etc.}$$

OBJECTIVE: Evaluate and (*most important!*) *visualize* matrix-exponent solutions.

$$|\Psi(t)\rangle = e^{-i\mathbf{H}t}|\Psi(0)\rangle$$

Hamilton generalized Euler's expansion $e^{-i\omega t} = \cos \omega t - i \sin \omega t$ so matrix exponential becomes powerful.

$$e^{-i\mathbf{H}t} = e^{-i \begin{pmatrix} A & B-iC \\ B+iC & D \end{pmatrix} t} = e^{-i \frac{A-D}{2} \begin{pmatrix} 1 & 0 \\ 0 & -1 \end{pmatrix} t - iB \begin{pmatrix} 0 & 1 \\ 1 & 0 \end{pmatrix} t - iC \begin{pmatrix} 0 & -i \\ i & 0 \end{pmatrix} t - i \frac{A+D}{2} \begin{pmatrix} 1 & 0 \\ 0 & 1 \end{pmatrix} t}$$

$\sigma_A = \sigma_Z$ $\sigma_B = \sigma_X$ $\sigma_C = \sigma_Y$

$$= e^{-i\sigma_\varphi \varphi} e^{-i\omega_0 t} = e^{-i\vec{\sigma} \cdot \vec{\omega} t} e^{-i\omega_0 t} \text{ where: } \vec{\varphi} = \begin{pmatrix} \varphi_A \\ \varphi_B \\ \varphi_C \end{pmatrix} = \vec{\omega} \cdot t = \begin{pmatrix} \omega_A \\ \omega_B \\ \omega_C \end{pmatrix} \cdot t = \begin{pmatrix} \frac{A-D}{2} \\ B \\ C \end{pmatrix} \cdot t \text{ and: } \omega_0 = \frac{A+D}{2}$$

ABCD Time evolution operator

For constant A, B, C, and D

Symmetry relations make spinors $\sigma_X = \sigma_B$, $\sigma_Y = \sigma_C$, and $\sigma_Z = \sigma_A$ or quaternions $\mathbf{i} = -i\sigma_X$, $\mathbf{j} = -i\sigma_Y$, and $\mathbf{k} = -i\sigma_Z$ powerful.

Hamilton is able to generalize Euler's complex rotation operators $e^{+i\varphi}$ and $e^{-i\varphi}$. (Recall (1.10.17).)

$$e^{-i\varphi} = 1 + (-i\varphi) + \frac{1}{2!}(-i\varphi)^2 + \frac{1}{3!}(-i\varphi)^3 + \frac{1}{4!}(-i\varphi)^4 \dots = [1 - \frac{1}{2!}\varphi^2 + \frac{1}{4!}\varphi^4 \dots] = [\cos \varphi]$$

$$[-i\varphi + \frac{1}{3!}\varphi^3 \dots] = -i(\sin \varphi)$$

Note even powers of $(-i)$ are ± 1 and odd powers of $(-i)$ are $\pm i$: $(-i)^0 = +1$, $(-i)^1 = -i$, $(-i)^2 = -1$, $(-i)^3 = +i$, $(-i)^4 = +1$, $(-i)^5 = -i$, etc.

Hamilton replaces $(-i)$ with $-i\sigma_\varphi$ in the $e^{-i\varphi}$ power series above to get a sequence of terms just like it.

$$(-i\sigma_\varphi)^0 = +1, (-i\sigma_\varphi)^1 = -i\sigma_\varphi, (-i\sigma_\varphi)^2 = -1, (-i\sigma_\varphi)^3 = +i\sigma_\varphi, (-i\sigma_\varphi)^4 = +1, (-i\sigma_\varphi)^5 = -i\sigma_\varphi, \text{ etc.}$$

This allows Hamilton to generalize Euler's rotation $e^{-i\varphi}$ to $e^{-i\sigma_\varphi \varphi}$ for any $\sigma_\varphi \varphi = (\boldsymbol{\sigma} \cdot \vec{\varphi}) = \varphi_A \sigma_A + \varphi_B \sigma_B + \varphi_Z \sigma_Z = (\boldsymbol{\sigma} \cdot \hat{\varphi})\varphi$

$$e^{-i\varphi} = 1 \cos \varphi - i \sin \varphi$$

generalizes to: $e^{-i\sigma_\varphi \varphi} = 1 \cos \varphi - i \sigma_\varphi \sin \varphi$

OBJECTIVE: Evaluate and (*most important!*) *visualize* matrix-exponent solutions.

$$|\Psi(t)\rangle = e^{-i\mathbf{H}t}|\Psi(0)\rangle$$

Hamilton generalized Euler's expansion $e^{-i\omega t} = \cos \omega t - i \sin \omega t$ so matrix exponential becomes powerful.

$$e^{-i\mathbf{H}t} = e^{-i \begin{pmatrix} A & B-iC \\ B+iC & D \end{pmatrix} t} = e^{-i \frac{A-D}{2} \begin{pmatrix} 1 & 0 \\ 0 & -1 \end{pmatrix} t} e^{-iB \begin{pmatrix} 0 & 1 \\ 1 & 0 \end{pmatrix} t} e^{-iC \begin{pmatrix} 0 & -i \\ i & 0 \end{pmatrix} t} e^{-i \frac{A+D}{2} \begin{pmatrix} 1 & 0 \\ 0 & 1 \end{pmatrix} t}$$

$\sigma_A = \sigma_Z$ $\sigma_B = \sigma_X$ $\sigma_C = \sigma_Y$

$$= e^{-i\sigma_\varphi \varphi} e^{-i\omega_0 t} = e^{-i\vec{\sigma} \cdot \vec{\omega} t} e^{-i\omega_0 t} \text{ where: } \vec{\varphi} = \begin{pmatrix} \varphi_A \\ \varphi_B \\ \varphi_C \end{pmatrix} = \vec{\omega} \cdot t = \begin{pmatrix} \omega_A \\ \omega_B \\ \omega_C \end{pmatrix} \cdot t = \begin{pmatrix} \frac{A-D}{2} \\ B \\ C \end{pmatrix} \cdot t \text{ and: } \omega_0 = \frac{A+D}{2}$$

$$= (\mathbf{1} \cos \varphi - i \sigma_\varphi \sin \varphi) e^{-i\omega_0 t}$$

ABCD Time evolution operator

For constant A, B, C, and D

Symmetry relations make spinors $\sigma_X = \sigma_B$, $\sigma_Y = \sigma_C$, and $\sigma_Z = \sigma_A$ or quaternions $\mathbf{i} = -i\sigma_X$, $\mathbf{j} = -i\sigma_Y$, and $\mathbf{k} = -i\sigma_Z$ powerful.

Hamilton is able to generalize Euler's complex rotation operators $e^{+i\varphi}$ and $e^{-i\varphi}$. (Recall (1.10.17).)

$$e^{-i\varphi} = 1 + (-i\varphi) + \frac{1}{2!}(-i\varphi)^2 + \frac{1}{3!}(-i\varphi)^3 + \frac{1}{4!}(-i\varphi)^4 \dots = [1 - \frac{1}{2!}\varphi^2 + \frac{1}{4!}\varphi^4 \dots] = [\cos \varphi]$$

$$[-i\varphi + \frac{1}{3!}\varphi^3 \dots] = -i(\sin \varphi)$$

Note even powers of $(-i)$ are ± 1 and odd powers of $(-i)$ are $\pm i$: $(-i)^0 = +1$, $(-i)^1 = -i$, $(-i)^2 = -1$, $(-i)^3 = +i$, $(-i)^4 = +1$, $(-i)^5 = -i$, etc.

Hamilton replaces $(-i)$ with $-i\sigma_\varphi$ in the $e^{-i\varphi}$ power series above to get a sequence of terms just like it.

$$(-i\sigma_\varphi)^0 = +\mathbf{1}, \quad (-i\sigma_\varphi)^1 = -i\sigma_\varphi, \quad (-i\sigma_\varphi)^2 = -\mathbf{1}, \quad (-i\sigma_\varphi)^3 = +i\sigma_\varphi, \quad (-i\sigma_\varphi)^4 = +\mathbf{1}, \quad (-i\sigma_\varphi)^5 = -i\sigma_\varphi, \text{ etc.}$$

This allows Hamilton to generalize Euler's rotation $e^{-i\varphi}$ to $e^{-i\sigma_\varphi \varphi}$ for any $\sigma_\varphi \varphi = (\boldsymbol{\sigma} \cdot \vec{\varphi}) = \varphi_A \sigma_A + \varphi_B \sigma_B + \varphi_Z \sigma_Z = (\boldsymbol{\sigma} \cdot \hat{\varphi})\varphi$

$$e^{-i\varphi} = \mathbf{1} \cos \varphi - i \sin \varphi$$

generalizes to: $e^{-i\sigma_\varphi \varphi} = \mathbf{1} \cos \varphi - i \sigma_\varphi \sin \varphi$

The Crazy Thing Theorem:

If $(\text{smiley})^2 = -\mathbf{1}$

Then:

$$e^{(\text{smiley})\varphi} = \mathbf{1} \cos \varphi + (\text{smiley}) \sin \varphi$$

OBJECTIVE: Evaluate and (*most important!*) *visualize* matrix-exponent solutions.

$$|\Psi(t)\rangle = e^{-i\mathbf{H}t}|\Psi(0)\rangle$$

Hamilton generalized Euler's expansion $e^{-i\omega t} = \cos \omega t - i \sin \omega t$ so matrix exponential becomes powerful.

$$e^{-i\mathbf{H}t} = e^{-i \begin{pmatrix} A & B-iC \\ B+iC & D \end{pmatrix} t} = e^{-i \frac{A-D}{2} \begin{pmatrix} 1 & 0 \\ 0 & -1 \end{pmatrix} t} e^{-iB \begin{pmatrix} 0 & 1 \\ 1 & 0 \end{pmatrix} t} e^{-iC \begin{pmatrix} 0 & -i \\ i & 0 \end{pmatrix} t} e^{-i \frac{A+D}{2} \begin{pmatrix} 1 & 0 \\ 0 & 1 \end{pmatrix} t}$$

$\sigma_A = \sigma_Z$ $\sigma_B = \sigma_X$ $\sigma_C = \sigma_Y$

$$= e^{-i\sigma_\varphi \varphi} e^{-i\omega_0 t} = e^{-i\vec{\sigma} \cdot \vec{\omega} t} e^{-i\omega_0 t}$$

where: $\vec{\varphi} = \begin{pmatrix} \varphi_A \\ \varphi_B \\ \varphi_C \end{pmatrix} = \vec{\omega} \cdot t = \begin{pmatrix} \omega_A \\ \omega_B \\ \omega_C \end{pmatrix} \cdot t = \begin{pmatrix} \frac{A-D}{2} \\ B \\ C \end{pmatrix} \cdot t$ and: $\omega_0 = \frac{A+D}{2}$

$$= (\mathbf{1} \cos \varphi - i \sigma_\varphi \sin \varphi) e^{-i\omega_0 t}$$

ABCD Time evolution operator

For constant A, B, C, and D

Symmetry relations make spinors $\sigma_X = \sigma_B$, $\sigma_Y = \sigma_C$, and $\sigma_Z = \sigma_A$ or quaternions $\mathbf{i} = -i\sigma_X$, $\mathbf{j} = -i\sigma_Y$, and $\mathbf{k} = -i\sigma_Z$ powerful.

Hamilton is able to generalize Euler's complex rotation operators $e^{+i\varphi}$ and $e^{-i\varphi}$. (Recall (1.10.17).)

$$e^{-i\varphi} = 1 + (-i\varphi) + \frac{1}{2!}(-i\varphi)^2 + \frac{1}{3!}(-i\varphi)^3 + \frac{1}{4!}(-i\varphi)^4 \dots = [1 - \frac{1}{2!}\varphi^2 + \frac{1}{4!}\varphi^4 \dots] = [\cos \varphi]$$

$$[-i\varphi + \frac{1}{3!}\varphi^3 \dots] = -i(\sin \varphi)$$

Note even powers of $(-i)$ are ± 1 and odd powers of $(-i)$ are $\pm i$: $(-i)^0 = +1$, $(-i)^1 = -i$, $(-i)^2 = -1$, $(-i)^3 = +i$, $(-i)^4 = +1$, $(-i)^5 = -i$, etc.

Hamilton replaces $(-i)$ with $-i\sigma_\varphi$ in the $e^{-i\varphi}$ power series above to get a sequence of terms just like it.

$$(-i\sigma_\varphi)^0 = +1, (-i\sigma_\varphi)^1 = -i\sigma_\varphi, (-i\sigma_\varphi)^2 = -1, (-i\sigma_\varphi)^3 = +i\sigma_\varphi, (-i\sigma_\varphi)^4 = +1, (-i\sigma_\varphi)^5 = -i\sigma_\varphi, \text{ etc.}$$

This allows Hamilton to generalize Euler's rotation $e^{-i\varphi}$ to $e^{-i\sigma_\varphi \varphi}$ for any $\sigma_\varphi \varphi = (\vec{\sigma} \cdot \vec{\varphi}) = \varphi_A \sigma_A + \varphi_B \sigma_B + \varphi_C \sigma_C = (\vec{\sigma} \cdot \hat{\varphi})\varphi$

$$e^{-i\varphi} = \mathbf{1} \cos \varphi - i \sin \varphi$$

generalizes to: $e^{-i\sigma_\varphi \varphi} = \mathbf{1} \cos \varphi - i \sigma_\varphi \sin \varphi$

Here:  = $-i$

Crazy thing is just $-\sqrt{-1}$

Here:  = $-i\sigma_\varphi = -i(\vec{\sigma} \cdot \hat{\varphi}) = -i \frac{(\vec{\sigma} \cdot \vec{\varphi})}{\varphi}$

The Crazy Thing Theorem:
If ² = $-\mathbf{1}$
Then:
 $e(\img alt="smiley face with blue eyes" data-bbox="835 635 875 670"/>^{\varphi}) = $\mathbf{1} \cos \varphi + (\img alt="smiley face with blue eyes" data-bbox="835 635 875 670") \sin \varphi$$

*ANALOGY: 2-State Schrodinger: $i\hbar\partial_t|\Psi(t)\rangle = \mathbf{H}|\Psi(t)\rangle$ versus Classical 2D-HO: $\partial_t^2\mathbf{x} = -\mathbf{K}\cdot\mathbf{x}$
Hamilton-Pauli spinor symmetry (σ -expansion in *ABCD*-Types) $\mathbf{H} = \omega_\mu\sigma_\mu$*

Derive σ -exponential time evolution (or revolution) operator $\mathbf{U} = e^{-i\mathbf{H}t} = e^{-i\sigma_\mu\omega_\mu t}$

Spinor arithmetic like complex arithmetic

Spinor vector algebra like complex vector algebra

Spinor exponentials like complex exponentials (“Crazy-Thing”-Theorem)

➔ *Geometry of evolution (or revolution) operator $\mathbf{U} = e^{-i\mathbf{H}t} = e^{-i\sigma_\mu\omega_\mu t}$*

The “mysterious” factors of 2 (or 1/2): 2D Spinor vs 3D Spin Vector space

2D Spinor vs 3D vector rotation

NMR Hamiltonian: 3D Spin Moment \mathbf{m} in \mathbf{B} field

OBJECTIVE: Evaluate and (*most important!*) *visualize* matrix-exponent solutions.

ABCD Time evolution operator
For constant *A, B, C, and D*

$$|\Psi(t)\rangle = e^{-i\mathbf{H}t}|\Psi(0)\rangle$$

Hamilton generalized Euler's expansion $e^{-i\Omega t} = \cos \Omega t - i \sin \Omega t$ so matrix exponential becomes powerful.

$$e^{-i\mathbf{H}t} = e^{-i \begin{pmatrix} A & B-iC \\ B+iC & D \end{pmatrix} t} = e^{-i \frac{A-D}{2} \begin{pmatrix} 1 & 0 \\ 0 & -1 \end{pmatrix} t - iB \begin{pmatrix} 0 & 1 \\ 1 & 0 \end{pmatrix} t - iC \begin{pmatrix} 0 & -i \\ i & 0 \end{pmatrix} t - i \frac{A+D}{2} \begin{pmatrix} 1 & 0 \\ 0 & 1 \end{pmatrix} t} = e^{-i(\omega_0 \sigma_0 + \vec{\omega} \cdot \vec{\sigma})t} = e^{-i\omega_0 t} \left(\mathbf{1} \cos \omega t - i \sigma_\varphi \sin \omega t \right)$$

$\sigma_A = \sigma_Z$ $\sigma_B = \sigma_X$ $\sigma_C = \sigma_Y$

where: $\vec{\varphi} = \begin{pmatrix} \varphi_A \\ \varphi_B \\ \varphi_C \end{pmatrix} = \vec{\omega} \cdot t = \begin{pmatrix} \omega_A \\ \omega_B \\ \omega_C \end{pmatrix} \cdot t = \begin{pmatrix} \frac{A-D}{2} \\ B \\ C \end{pmatrix} \cdot t$ and: $\omega_0 = \frac{A+D}{2}$

$$e^{-i\varphi} = \mathbf{1} \cos \varphi - i \sin \varphi$$

generalizes to:

$$e^{-i\sigma_\varphi \varphi} = \mathbf{1} \cos \varphi - i \sigma_\varphi \sin \varphi$$

$$e^{-i \begin{pmatrix} 1 & 0 \\ 0 & -1 \end{pmatrix} \varphi_A} = \begin{pmatrix} 1 & 0 \\ 0 & 1 \end{pmatrix} \cos \varphi_A - i \begin{pmatrix} 1 & 0 \\ 0 & -1 \end{pmatrix} \sin \varphi_A$$

$$= \begin{pmatrix} \cos \varphi_A - i \sin \varphi_A & 0 \\ 0 & \cos \varphi_A - i \sin \varphi_A \end{pmatrix} = \begin{pmatrix} e^{-i\varphi_A} & 0 \\ 0 & e^{i\varphi_A} \end{pmatrix}$$

Example 1:
A or Z rotation

The Crazy Thing Theorem:

If $(i)^2 = -1$

Then:

$$e^{i\varphi} = \mathbf{1} \cos \varphi + (i) \sin \varphi$$

OBJECTIVE: Evaluate and (*most important!*) *visualize* matrix-exponent solutions.

ABCD Time evolution operator
For constant *A, B, C, and D*

$$|\Psi(t)\rangle = e^{-i\mathbf{H}t}|\Psi(0)\rangle$$

Hamilton generalized Euler's expansion $e^{-i\Omega t} = \cos \Omega t - i \sin \Omega t$ so matrix exponential becomes powerful.

$$e^{-i\mathbf{H}t} = e^{-i \begin{pmatrix} A & B-iC \\ B+iC & D \end{pmatrix} t} = e^{-i \frac{A-D}{2} \begin{pmatrix} 1 & 0 \\ 0 & -1 \end{pmatrix} t - iB \begin{pmatrix} 0 & 1 \\ 1 & 0 \end{pmatrix} t - iC \begin{pmatrix} 0 & -i \\ i & 0 \end{pmatrix} t - i \frac{A+D}{2} \begin{pmatrix} 1 & 0 \\ 0 & 1 \end{pmatrix} t} = e^{-i(\omega_0 \sigma_0 + \vec{\omega} \cdot \vec{\sigma})t} = e^{-i\omega_0 t} \left(\mathbf{1} \cos \omega t - i \sigma_\varphi \sin \omega t \right)$$

$\sigma_A = \sigma_Z$ $\sigma_B = \sigma_X$ $\sigma_C = \sigma_Y$

where: $\vec{\varphi} = \begin{pmatrix} \varphi_A \\ \varphi_B \\ \varphi_C \end{pmatrix} = \vec{\omega} \cdot t = \begin{pmatrix} \omega_A \\ \omega_B \\ \omega_C \end{pmatrix} \cdot t = \begin{pmatrix} \frac{A-D}{2} \\ B \\ C \end{pmatrix} \cdot t$ and: $\omega_0 = \frac{A+D}{2}$

$$e^{-i\varphi} = \mathbf{1} \cos \varphi - i \sin \varphi$$

generalizes to:

$$e^{-i\sigma_\varphi \varphi} = \mathbf{1} \cos \varphi - i \sigma_\varphi \sin \varphi$$

$$e^{-i \begin{pmatrix} 1 & 0 \\ 0 & -1 \end{pmatrix} \varphi_A} = \begin{pmatrix} 1 & 0 \\ 0 & 1 \end{pmatrix} \cos \varphi_A - i \begin{pmatrix} 1 & 0 \\ 0 & -1 \end{pmatrix} \sin \varphi_A$$

$$= \begin{pmatrix} \cos \varphi_A - i \sin \varphi_A & 0 \\ 0 & \cos \varphi_A - i \sin \varphi_A \end{pmatrix} = \begin{pmatrix} e^{-i\varphi_A} & 0 \\ 0 & e^{i\varphi_A} \end{pmatrix}$$

Example 1:
A or Z
rotation

$$e^{-i \begin{pmatrix} 0 & -i \\ i & 0 \end{pmatrix} \varphi_C} = \begin{pmatrix} 1 & 0 \\ 0 & 1 \end{pmatrix} \cos \varphi_C - i \begin{pmatrix} 0 & -i \\ i & 0 \end{pmatrix} \sin \varphi_C$$

$$= \begin{pmatrix} \cos \varphi_C & -\sin \varphi_C \\ \sin \varphi_C & \cos \varphi_C \end{pmatrix}$$

Example 2:
C or Y
rotation

The Crazy Thing Theorem:

If $(\text{smiley})^2 = -\mathbf{1}$

Then:

$$e^{(\text{smiley})\varphi} = \mathbf{1} \cos \varphi + (\text{smiley}) \sin \varphi$$

OBJECTIVE: Evaluate and (*most important!*) *visualize* matrix-exponent solutions.

ABCD Time evolution operator
For constant *A, B, C, and D*

$$|\Psi(t)\rangle = e^{-i\mathbf{H}t}|\Psi(0)\rangle$$

Hamilton generalized Euler's expansion $e^{-i\Omega t} = \cos \Omega t - i \sin \Omega t$ so matrix exponential becomes powerful.

$$e^{-i\mathbf{H}t} = e^{-i \begin{pmatrix} A & B-iC \\ B+iC & D \end{pmatrix} t} = e^{-i \frac{A-D}{2} \begin{pmatrix} 1 & 0 \\ 0 & -1 \end{pmatrix} t - iB \begin{pmatrix} 0 & 1 \\ 1 & 0 \end{pmatrix} t - iC \begin{pmatrix} 0 & -i \\ i & 0 \end{pmatrix} t - i \frac{A+D}{2} \begin{pmatrix} 1 & 0 \\ 0 & 1 \end{pmatrix} t} = e^{-i(\omega_0 \sigma_0 + \vec{\omega} \cdot \vec{\sigma})t} = e^{-i\omega_0 t} \left(\mathbf{1} \cos \omega t - i \sigma_\varphi \sin \omega t \right)$$

$\sigma_A = \sigma_Z$ $\sigma_B = \sigma_X$ $\sigma_C = \sigma_Y$

where: $\vec{\varphi} = \begin{pmatrix} \varphi_A \\ \varphi_B \\ \varphi_C \end{pmatrix} = \vec{\omega} \cdot t = \begin{pmatrix} \omega_A \\ \omega_B \\ \omega_C \end{pmatrix} \cdot t = \begin{pmatrix} \frac{A-D}{2} \\ B \\ C \end{pmatrix} \cdot t$ and: $\omega_0 = \frac{A+D}{2}$

$$e^{-i\varphi} = \mathbf{1} \cos \varphi - i \sin \varphi$$

generalizes to:

$$e^{-i\sigma_\varphi \varphi} = \mathbf{1} \cos \varphi - i \sigma_\varphi \sin \varphi$$

$$e^{-i \begin{pmatrix} 1 & 0 \\ 0 & -1 \end{pmatrix} \varphi_A} = \begin{pmatrix} 1 & 0 \\ 0 & 1 \end{pmatrix} \cos \varphi_A - i \begin{pmatrix} 1 & 0 \\ 0 & -1 \end{pmatrix} \sin \varphi_A$$

$$= \begin{pmatrix} \cos \varphi_A - i \sin \varphi_A & 0 \\ 0 & \cos \varphi_A - i \sin \varphi_A \end{pmatrix} = \begin{pmatrix} e^{-i\varphi_A} & 0 \\ 0 & e^{i\varphi_A} \end{pmatrix}$$

Example 1:
A or Z
rotation

$$e^{-i \begin{pmatrix} 0 & -i \\ i & 0 \end{pmatrix} \varphi_C} = \begin{pmatrix} 1 & 0 \\ 0 & 1 \end{pmatrix} \cos \varphi_C - i \begin{pmatrix} 0 & -i \\ i & 0 \end{pmatrix} \sin \varphi_C$$

$$= \begin{pmatrix} \cos \varphi_C & -\sin \varphi_C \\ \sin \varphi_C & \cos \varphi_C \end{pmatrix}$$

Example 2:
C or Y
rotation

Let: $\vec{\varphi} = \vec{\omega} \cdot t$

$$e^{-i(\sigma \cdot \vec{\varphi})t} = \mathbf{1} \cos \varphi - i \sigma_\varphi \sin \varphi = \mathbf{1} \cos \varphi - i (\sigma \cdot \hat{\varphi}) \sin \varphi$$

$$= \mathbf{1} \cos \varphi - i (\sigma_A \hat{\varphi}_A) \sin \varphi - i (\sigma_B \hat{\varphi}_B) \sin \varphi - i (\sigma_C \hat{\varphi}_C) \sin \varphi$$

$$= \begin{pmatrix} 1 & 0 \\ 0 & 1 \end{pmatrix} \cos \varphi - i \begin{pmatrix} 1 & 0 \\ 0 & -1 \end{pmatrix} \hat{\varphi}_A \sin \varphi - i \begin{pmatrix} 0 & 1 \\ 1 & 0 \end{pmatrix} \hat{\varphi}_B \sin \varphi - i \begin{pmatrix} 0 & -i \\ i & 0 \end{pmatrix} \hat{\varphi}_C \sin \varphi$$

$$= \begin{pmatrix} \cos \varphi - i \hat{\varphi}_A \sin \varphi & (-i \hat{\varphi}_B - \hat{\varphi}_C) \sin \varphi \\ (-i \hat{\varphi}_B + \hat{\varphi}_C) \sin \varphi & \cos \varphi + i \hat{\varphi}_A \sin \varphi \end{pmatrix}$$

Example 3:
Any $\varphi = \omega t$ -axial
rotation

The Crazy Thing Theorem:
If $(i)^2 = -1$
Then:
 $e^{(i)\varphi} = \mathbf{1} \cos \varphi + (i) \sin \varphi$

OBJECTIVE: Evaluate and (*most important!*) *visualize* matrix-exponent solutions.

ABCD Time evolution operator
For constant *A, B, C, and D*

$$|\Psi(t)\rangle = e^{-i\mathbf{H}t}|\Psi(0)\rangle$$

Hamilton generalized Euler's expansion $e^{-i\Omega t} = \cos \Omega t - i \sin \Omega t$ so matrix exponential becomes powerful.

$$e^{-i\mathbf{H}t} = e^{-i \begin{pmatrix} A & B-iC \\ B+iC & D \end{pmatrix} t} = e^{-i \frac{A-D}{2} \begin{pmatrix} 1 & 0 \\ 0 & -1 \end{pmatrix} t - iB \begin{pmatrix} 0 & 1 \\ 1 & 0 \end{pmatrix} t - iC \begin{pmatrix} 0 & -i \\ i & 0 \end{pmatrix} t - i \frac{A+D}{2} \begin{pmatrix} 1 & 0 \\ 0 & 1 \end{pmatrix} t} = e^{-i(\omega_0 \sigma_0 + \vec{\omega} \cdot \vec{\sigma})t} = e^{-i\omega_0 t} \left(\mathbf{1} \cos \omega t - i \sigma_\varphi \sin \omega t \right)$$

$\sigma_A = \sigma_Z$ $\sigma_B = \sigma_X$ $\sigma_C = \sigma_Y$

where: $\vec{\varphi} = \begin{pmatrix} \varphi_A \\ \varphi_B \\ \varphi_C \end{pmatrix} = \vec{\omega} \cdot t = \begin{pmatrix} \omega_A \\ \omega_B \\ \omega_C \end{pmatrix} \cdot t = \begin{pmatrix} \frac{A-D}{2} \\ B \\ C \end{pmatrix} \cdot t$ and: $\omega_0 = \frac{A+D}{2}$

$$e^{-i\varphi} = \mathbf{1} \cos \varphi - i \sin \varphi$$

generalizes to:

$$e^{-i\sigma_\varphi \varphi} = \mathbf{1} \cos \varphi - i \sigma_\varphi \sin \varphi$$

$$e^{-i \begin{pmatrix} 1 & 0 \\ 0 & -1 \end{pmatrix} \varphi_A} = \begin{pmatrix} 1 & 0 \\ 0 & 1 \end{pmatrix} \cos \varphi_A - i \begin{pmatrix} 1 & 0 \\ 0 & -1 \end{pmatrix} \sin \varphi_A$$

$$= \begin{pmatrix} \cos \varphi_A & -i \sin \varphi_A & 0 \\ 0 & \cos \varphi_A & -i \sin \varphi_A \end{pmatrix} = \begin{pmatrix} e^{-i\varphi_A} & 0 \\ 0 & e^{i\varphi_A} \end{pmatrix}$$

Example 1:
A or Z
rotation

$$e^{-i \begin{pmatrix} 0 & -i \\ i & 0 \end{pmatrix} \varphi_C} = \begin{pmatrix} 1 & 0 \\ 0 & 1 \end{pmatrix} \cos \varphi_C - i \begin{pmatrix} 0 & -i \\ i & 0 \end{pmatrix} \sin \varphi_C$$

$$= \begin{pmatrix} \cos \varphi_C & -\sin \varphi_C \\ \sin \varphi_C & \cos \varphi_C \end{pmatrix}$$

Example 2:
C or Y
rotation

We test these operators by making them rotate each other....

OBJECTIVE: Evaluate and (*most important!*) *visualize* matrix-exponent solutions.

ABCD Time evolution operator
For constant *A, B, C, and D*

$$|\Psi(t)\rangle = e^{-i\mathbf{H}t}|\Psi(0)\rangle$$

Hamilton generalized Euler's expansion $e^{-i\Omega t} = \cos \Omega t - i \sin \Omega t$ so matrix exponential becomes powerful.

$$e^{-i\mathbf{H}t} = e^{-i \begin{pmatrix} A & B-iC \\ B+iC & D \end{pmatrix} t} = e^{-i \frac{A-D}{2} \begin{pmatrix} 1 & 0 \\ 0 & -1 \end{pmatrix} t - iB \begin{pmatrix} 0 & 1 \\ 1 & 0 \end{pmatrix} t - iC \begin{pmatrix} 0 & -i \\ i & 0 \end{pmatrix} t - i \frac{A+D}{2} \begin{pmatrix} 1 & 0 \\ 0 & 1 \end{pmatrix} t} = e^{-i(\omega_0 \sigma_0 + \vec{\omega} \cdot \vec{\sigma})t} = e^{-i\omega_0 t} \left(\mathbf{1} \cos \omega t - i \sigma_\varphi \sin \omega t \right)$$

$\sigma_A = \sigma_Z$ $\sigma_B = \sigma_X$ $\sigma_C = \sigma_Y$

$$e^{-i\varphi} = \mathbf{1} \cos \varphi - i \sin \varphi$$

generalizes to:

$$e^{-i\sigma_\varphi \varphi} = \mathbf{1} \cos \varphi - i \sigma_\varphi \sin \varphi$$

where: $\vec{\varphi} = \begin{pmatrix} \varphi_A \\ \varphi_B \\ \varphi_C \end{pmatrix} = \vec{\omega} \cdot t = \begin{pmatrix} \omega_A \\ \omega_B \\ \omega_C \end{pmatrix} \cdot t = \begin{pmatrix} \frac{A-D}{2} \\ B \\ C \end{pmatrix} \cdot t$ and: $\omega_0 = \frac{A+D}{2}$

$$e^{-i \begin{pmatrix} 1 & 0 \\ 0 & -1 \end{pmatrix} \varphi_A} = \begin{pmatrix} 1 & 0 \\ 0 & 1 \end{pmatrix} \cos \varphi_A - i \begin{pmatrix} 1 & 0 \\ 0 & -1 \end{pmatrix} \sin \varphi_A = \begin{pmatrix} \cos \varphi_A - i \sin \varphi_A & 0 \\ 0 & \cos \varphi_A - i \sin \varphi_A \end{pmatrix} = \begin{pmatrix} e^{-i\varphi_A} & 0 \\ 0 & e^{i\varphi_A} \end{pmatrix}$$

Example 1:
A or Z rotation

$$e^{-i \begin{pmatrix} 0 & -i \\ i & 0 \end{pmatrix} \varphi_C} = \begin{pmatrix} 1 & 0 \\ 0 & 1 \end{pmatrix} \cos \varphi_C - i \begin{pmatrix} 0 & -i \\ i & 0 \end{pmatrix} \sin \varphi_C = \begin{pmatrix} \cos \varphi_C & -\sin \varphi_C \\ \sin \varphi_C & \cos \varphi_C \end{pmatrix}$$

Example 2:
C or Y rotation

3D axis vector $\vec{\varphi} = \vec{\omega} \cdot t$ corresponds to generator $\sigma_\varphi = \sigma_A \hat{\varphi}_A + \sigma_B \hat{\varphi}_B + \sigma_C \hat{\varphi}_C$ of rotation $e^{-i\sigma_\varphi \varphi} = R(\vec{\varphi}) = \mathbf{1} \cos \varphi - i \sigma_\varphi \sin \varphi$ about axis $\vec{\varphi}$.

Any 2-by-2 σ_μ -matrix may be rotated by any $R(\vec{\varphi})$ matrix acting *twice* (fore-and-aft⁻¹) to give: $\sigma_\mu^{(\vec{\varphi}\text{-rotated})} = R(\vec{\varphi}) \sigma_\mu R^{-1}(\vec{\varphi}) = R(\vec{\varphi}) \sigma_\mu R^\dagger(\vec{\varphi})$

$$\begin{aligned} & \mathbf{R}(\varphi_C) \cdot \sigma_A \cdot \mathbf{R}^{-1}(\varphi_C) \\ &= \begin{pmatrix} \cos \varphi_C & -\sin \varphi_C \\ \sin \varphi_C & \cos \varphi_C \end{pmatrix} \begin{pmatrix} 1 & 0 \\ 0 & -1 \end{pmatrix} \begin{pmatrix} \cos \varphi_C & \sin \varphi_C \\ -\sin \varphi_C & \cos \varphi_C \end{pmatrix} \\ &= \begin{pmatrix} \cos^2 \varphi_C - \sin^2 \varphi_C & 2 \sin \varphi_C \cos \varphi_C \\ 2 \sin \varphi_C \cos \varphi_C & \sin^2 \varphi_C - \cos^2 \varphi_C \end{pmatrix} \\ &= \begin{pmatrix} 1 & 0 \\ 0 & -1 \end{pmatrix} \cos 2\varphi_C + \begin{pmatrix} 0 & 1 \\ 1 & 0 \end{pmatrix} \sin 2\varphi_C \\ &= \sigma_A \cos 2\varphi_C + \sigma_B \sin 2\varphi_C \end{aligned}$$

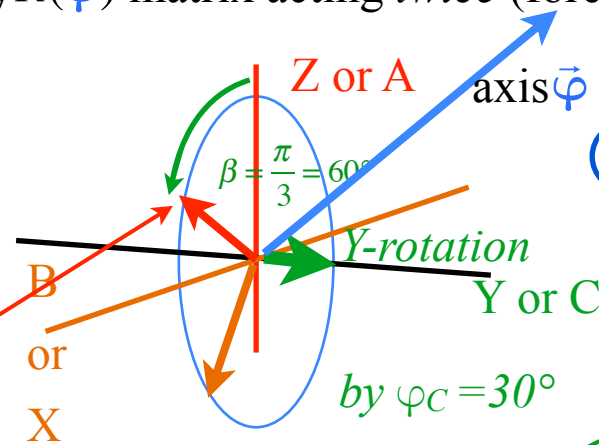

The 3D-rotation is by 2φ , *twice* the 2D angle φ .

by $\varphi_C = 30^\circ$
or: $\beta = 2\varphi_C = 60^\circ$

$$\hat{\varphi} = \begin{pmatrix} \hat{\varphi}_A \\ \hat{\varphi}_B \\ \hat{\varphi}_C \end{pmatrix} = \begin{pmatrix} \varphi_A \\ \varphi_B \\ \varphi_C \end{pmatrix} \frac{1}{\sqrt{\varphi_A^2 + \varphi_B^2 + \varphi_C^2}} = \begin{pmatrix} \omega_A \\ \omega_B \\ \omega_C \end{pmatrix} \frac{1}{\sqrt{\omega_A^2 + \omega_B^2 + \omega_C^2}}$$

OBJECTIVE: Evaluate and (*most important!*) *visualize* matrix-exponent solutions.

ABCD Time evolution operator
For constant *A, B, C, and D*

$$|\Psi(t)\rangle = e^{-i\mathbf{H}t}|\Psi(0)\rangle$$

Hamilton generalized Euler's expansion $e^{-i\Omega t} = \cos \Omega t - i \sin \Omega t$ so matrix exponential becomes powerful.

$$e^{-i\mathbf{H}t} = e^{-i \begin{pmatrix} A & B-iC \\ B+iC & D \end{pmatrix} t} = e^{-i \frac{A-D}{2} \begin{pmatrix} 1 & 0 \\ 0 & -1 \end{pmatrix} t - iB \begin{pmatrix} 0 & 1 \\ 1 & 0 \end{pmatrix} t - iC \begin{pmatrix} 0 & -i \\ i & 0 \end{pmatrix} t - i \frac{A+D}{2} \begin{pmatrix} 1 & 0 \\ 0 & 1 \end{pmatrix} t} = e^{-i(\omega_0 \sigma_0 + \vec{\omega} \cdot \vec{\sigma})t} = e^{-i\omega_0 t} \left(\mathbf{1} \cos \omega t - i \sigma_\varphi \sin \omega t \right)$$

$\sigma_A = \sigma_Z$ $\sigma_B = \sigma_X$ $\sigma_C = \sigma_Y$

where: $\vec{\varphi} = \begin{pmatrix} \varphi_A \\ \varphi_B \\ \varphi_C \end{pmatrix} = \vec{\omega} \cdot t = \begin{pmatrix} \omega_A \\ \omega_B \\ \omega_C \end{pmatrix} \cdot t = \begin{pmatrix} \frac{A-D}{2} \\ B \\ C \end{pmatrix} \cdot t$ and: $\omega_0 = \frac{A+D}{2}$

$$e^{-i\varphi} = \mathbf{1} \cos \varphi - i \sin \varphi$$

generalizes to:

$$e^{-i\sigma_\varphi \varphi} = \mathbf{1} \cos \varphi - i \sigma_\varphi \sin \varphi$$

$$e^{-i \begin{pmatrix} 1 & 0 \\ 0 & -1 \end{pmatrix} \varphi_A} = \begin{pmatrix} 1 & 0 \\ 0 & 1 \end{pmatrix} \cos \varphi_A - i \begin{pmatrix} 1 & 0 \\ 0 & -1 \end{pmatrix} \sin \varphi_A$$

$$= \begin{pmatrix} \cos \varphi_A & -i \sin \varphi_A & 0 \\ 0 & \cos \varphi_A & -i \sin \varphi_A \end{pmatrix} = \begin{pmatrix} e^{-i\varphi_A} & 0 \\ 0 & e^{i\varphi_A} \end{pmatrix}$$

Example 1:
A or Z
rotation

$$e^{-i \begin{pmatrix} 0 & -i \\ i & 0 \end{pmatrix} \varphi_C} = \begin{pmatrix} 1 & 0 \\ 0 & 1 \end{pmatrix} \cos \varphi_C - i \begin{pmatrix} 0 & -i \\ i & 0 \end{pmatrix} \sin \varphi_C$$

$$= \begin{pmatrix} \cos \varphi_C & -\sin \varphi_C \\ \sin \varphi_C & \cos \varphi_C \end{pmatrix}$$

Example 2:
C or Y
rotation

3D axis vector $\vec{\varphi} = \vec{\omega} \cdot t$ corresponds to generator $\sigma_\varphi = \sigma_A \hat{\varphi}_A + \sigma_B \hat{\varphi}_B + \sigma_C \hat{\varphi}_C$ of rotation $e^{-i\sigma_\varphi \varphi} = R(\vec{\varphi}) = \mathbf{1} \cos \varphi - i \sigma_\varphi \sin \varphi$ about axis $\vec{\varphi}$.

Any 2-by-2 σ_μ -matrix may be rotated by any $R(\vec{\varphi})$ matrix acting *twice* (fore-and-aft⁻¹) to give: $\sigma_\mu^{(\vec{\varphi}\text{-rotated})} = R(\vec{\varphi}) \sigma_\mu R^{-1}(\vec{\varphi}) = R(\vec{\varphi}) \sigma_\mu R^\dagger(\vec{\varphi})$

$$R(\varphi_C) \cdot \sigma_A \cdot R^{-1}(\varphi_C)$$

$$= \begin{pmatrix} \cos \varphi_C & -\sin \varphi_C \\ \sin \varphi_C & \cos \varphi_C \end{pmatrix} \begin{pmatrix} 1 & 0 \\ 0 & -1 \end{pmatrix} \begin{pmatrix} \cos \varphi_C & \sin \varphi_C \\ -\sin \varphi_C & \cos \varphi_C \end{pmatrix}$$

$$= \begin{pmatrix} \cos^2 \varphi_C - \sin^2 \varphi_C & 2 \sin \varphi_C \cos \varphi_C \\ 2 \sin \varphi_C \cos \varphi_C & \sin^2 \varphi_C - \cos^2 \varphi_C \end{pmatrix}$$

$$= \begin{pmatrix} 1 & 0 \\ 0 & -1 \end{pmatrix} \cos 2\varphi_C + \begin{pmatrix} 0 & 1 \\ 1 & 0 \end{pmatrix} \sin 2\varphi_C$$

$$= \sigma_A \cos 2\varphi_C + \sigma_B \sin 2\varphi_C$$

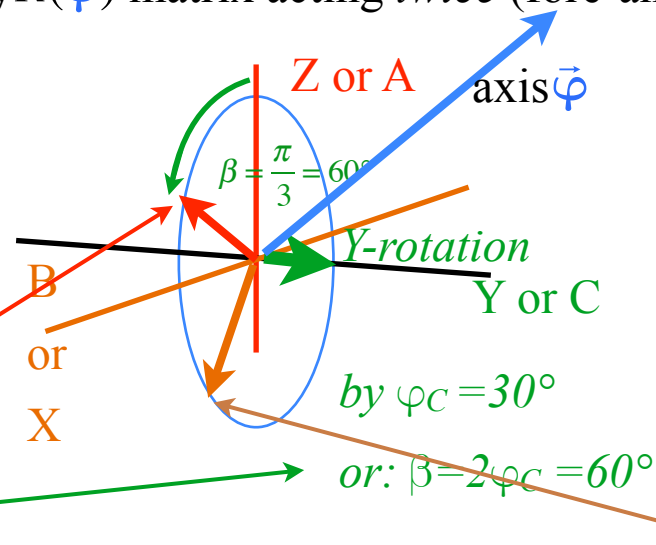

$$R(\varphi_C) \cdot \sigma_B \cdot R^{-1}(\varphi_C)$$

$$= \begin{pmatrix} \cos \varphi_C & -\sin \varphi_C \\ \sin \varphi_C & \cos \varphi_C \end{pmatrix} \begin{pmatrix} 0 & 1 \\ 1 & 0 \end{pmatrix} \begin{pmatrix} \cos \varphi_C & \sin \varphi_C \\ -\sin \varphi_C & \cos \varphi_C \end{pmatrix}$$

$$= \begin{pmatrix} -2 \sin \varphi_C \cos \varphi_C & \cos^2 \varphi_C - \sin^2 \varphi_C \\ \cos^2 \varphi_C - \sin^2 \varphi_C & 2 \sin \varphi_C \cos \varphi_C \end{pmatrix}$$

$$= \begin{pmatrix} -1 & 0 \\ 0 & 1 \end{pmatrix} \sin 2\varphi_C + \begin{pmatrix} 0 & 1 \\ 1 & 0 \end{pmatrix} \cos 2\varphi_C$$

$$= -\sigma_A \sin 2\varphi_C + \sigma_B \cos 2\varphi_C$$

The 3D-rotation is by 2φ , *twice* the 2D angle φ .

*ANALOGY: 2-State Schrodinger: $i\hbar\partial_t|\Psi(t)\rangle = \mathbf{H}|\Psi(t)\rangle$ versus Classical 2D-HO: $\partial_t^2\mathbf{x} = -\mathbf{K}\cdot\mathbf{x}$
Hamilton-Pauli spinor symmetry (σ -expansion in *ABCD*-Types) $\mathbf{H} = \omega_\mu \boldsymbol{\sigma}_\mu$*

Derive σ -exponential time evolution (or revolution) operator $\mathbf{U} = e^{-i\mathbf{H}t} = e^{-i\boldsymbol{\sigma}_\mu \omega_\mu t}$

Spinor arithmetic like complex arithmetic

Spinor vector algebra like complex vector algebra

Spinor exponentials like complex exponentials

Geometry of evolution (or revolution) operator $\mathbf{U} = e^{-i\mathbf{H}t} = e^{-i\boldsymbol{\sigma}_\mu \omega_\mu t}$

➔ The “mysterious” factors of 2 (or 1/2): 2D Spinor vs 3D Spin Vector space

2D Spinor vs 3D vector rotation

NMR Hamiltonian: 3D Spin Moment \mathbf{m} in \mathbf{B} field

The "mysterious" factors of 2 (or 1/2): 2D Spinor vs 3D Spin Vector space

$$\mathbf{H} = \begin{pmatrix} A & B - iC \\ B + iC & D \end{pmatrix} = \frac{A+D}{2} \begin{pmatrix} 1 & 0 \\ 0 & 1 \end{pmatrix} + \frac{A-D}{2} \begin{pmatrix} 1 & 0 \\ 0 & -1 \end{pmatrix} + B \begin{pmatrix} 0 & 1 \\ 1 & 0 \end{pmatrix} + C \begin{pmatrix} 0 & -i \\ i & 0 \end{pmatrix}$$

Notation for 2D Spinor space

$$= \omega_0 \sigma_0 + \omega_A \sigma_A + \omega_B \sigma_B + \omega_C \sigma_C = \omega_0 \sigma_0 + \vec{\omega} \cdot \vec{\sigma} = \omega_0 \mathbf{1} + \omega \sigma_\omega$$

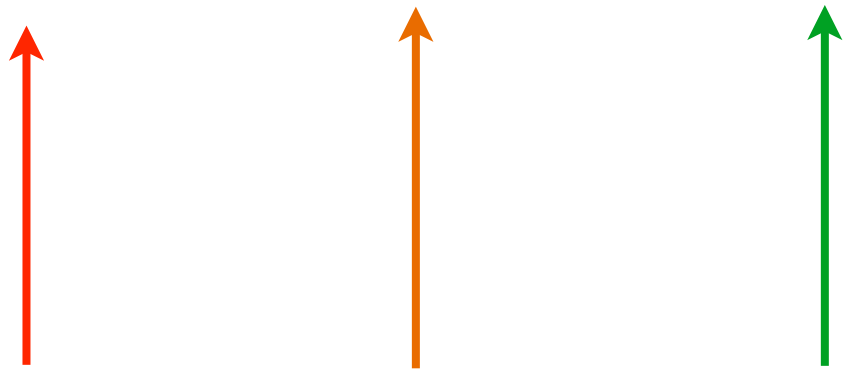

Symmetry archetypes: *A (Asymmetric-diagonal) | B (Bilateral-balanced) | C (Chiral-circular-complex...)*

The { $\sigma_I, \sigma_A, \sigma_B, \sigma_C$ } are the well known *Pauli-spin operators* { $\sigma_I = \sigma_0, \sigma_B = \sigma_X, \sigma_C = \sigma_Y, \sigma_A = \sigma_Z$ }

The "mysterious" factors of 2 (or 1/2): 2D Spinor vs 3D Spin Vector space

$$\begin{aligned}
 \mathbf{H} &= \begin{pmatrix} A & B-iC \\ B+iC & D \end{pmatrix} = \frac{A+D}{2} \begin{pmatrix} 1 & 0 \\ 0 & 1 \end{pmatrix} + \frac{A-D}{2} \begin{pmatrix} 1 & 0 \\ 0 & -1 \end{pmatrix} + B \begin{pmatrix} 0 & 1 \\ 1 & 0 \end{pmatrix} + C \begin{pmatrix} 0 & -i \\ i & 0 \end{pmatrix} && \text{Notation for 2D Spinor space} \\
 &= \omega_0 \sigma_0 + \omega_A \sigma_A + \omega_B \sigma_B + \omega_C \sigma_C = \omega_0 \sigma_0 + \vec{\omega} \cdot \vec{\sigma} = \omega_0 \mathbf{1} + \omega \sigma_\omega \\
 &= \Omega_0 \mathbf{1} + \Omega_A \mathbf{S}_A + \Omega_B \mathbf{S}_B + \Omega_C \mathbf{S}_C = \Omega_0 \mathbf{1} + \vec{\Omega} \cdot \vec{\mathbf{S}} \\
 &= \frac{A+D}{2} \begin{pmatrix} 1 & 0 \\ 0 & 1 \end{pmatrix} + (A-D) \begin{pmatrix} \frac{1}{2} & 0 \\ 0 & -\frac{1}{2} \end{pmatrix} + 2B \begin{pmatrix} 0 & \frac{1}{2} \\ \frac{1}{2} & 0 \end{pmatrix} + 2C \begin{pmatrix} 0 & -\frac{i}{2} \\ \frac{i}{2} & 0 \end{pmatrix} && \text{Notation for 3D Vector space} \\
 &\quad \text{0}^{\text{th}} \text{ component unchanged} \quad \text{components } A, B, C \text{ switch } 1/2\text{-factor from } \omega\text{-velocity to } S\text{-momentum}
 \end{aligned}$$

Symmetry archetypes: *A* (Asymmetric-diagonal) | *B* (Bilateral-balanced) | *C* (Chiral-circular-complex...)

The { $\sigma_I, \sigma_A, \sigma_B, \sigma_C$ } are the well known *Pauli-spin operators* { $\sigma_I = \sigma_0, \sigma_B = \sigma_X, \sigma_C = \sigma_Y, \sigma_A = \sigma_Z$ }

The “mysterious” factors of 2 (or 1/2): 2D Spinor vs 3D Spin Vector space

$$\begin{aligned}
 \mathbf{H} &= \begin{pmatrix} A & B-iC \\ B+iC & D \end{pmatrix} = \frac{A+D}{2} \begin{pmatrix} 1 & 0 \\ 0 & 1 \end{pmatrix} + \frac{A-D}{2} \begin{pmatrix} 1 & 0 \\ 0 & -1 \end{pmatrix} + B \begin{pmatrix} 0 & 1 \\ 1 & 0 \end{pmatrix} + C \begin{pmatrix} 0 & -i \\ i & 0 \end{pmatrix} && \text{Notation for} \\
 & && \text{2D Spinor space} \\
 &= \omega_0 \sigma_0 + \omega_A \sigma_A + \omega_B \sigma_B + \omega_C \sigma_C = \omega_0 \sigma_0 + \vec{\omega} \cdot \vec{\sigma} = \omega_0 \mathbf{1} + \omega \sigma_\omega \\
 &= \Omega_0 \mathbf{1} + \Omega_A \mathbf{S}_A + \Omega_B \mathbf{S}_B + \Omega_C \mathbf{S}_C = \Omega_0 \mathbf{1} + \vec{\Omega} \cdot \vec{\mathbf{S}} \\
 &= \frac{A+D}{2} \begin{pmatrix} 1 & 0 \\ 0 & 1 \end{pmatrix} + (A-D) \begin{pmatrix} \frac{1}{2} & 0 \\ 0 & -\frac{1}{2} \end{pmatrix} + 2B \begin{pmatrix} 0 & \frac{1}{2} \\ \frac{1}{2} & 0 \end{pmatrix} + 2C \begin{pmatrix} 0 & -\frac{i}{2} \\ \frac{i}{2} & 0 \end{pmatrix} && \text{Notation for} \\
 & && \text{3D Vector space} \\
 & \text{0}^{\text{th}} \text{ component} && \text{unchanged} && \text{components } A, B, C \text{ switch } 1/2\text{-factor from } \omega\text{-velocity to } S\text{-momentum}
 \end{aligned}$$

Symmetry archetypes: *A* (Asymmetric-diagonal) | *B* (Bilateral-balanced) | *C* (Chiral-circular-complex...)

The { $\sigma_I, \sigma_A, \sigma_B, \sigma_C$ } are the well known *Pauli-spin operators* { $\sigma_I = \sigma_0, \sigma_B = \sigma_X, \sigma_C = \sigma_Y, \sigma_A = \sigma_Z$ }

The { $\mathbf{1}, \mathbf{S}_A, \mathbf{S}_B, \mathbf{S}_C$ } are the *Jordan-Angular-Momentum operators* { $\mathbf{1} = \sigma_0, \mathbf{S}_B = \mathbf{S}_X, \mathbf{S}_C = \mathbf{S}_Y, \mathbf{S}_A = \mathbf{S}_Z$ }
 (Often labeled { $\mathbf{J}_X, \mathbf{J}_Y, \mathbf{J}_Z$ })

The "mysterious" factors of 2 (or 1/2): 2D Spinor vs 3D Spin Vector space

$$\begin{aligned}
 \mathbf{H} &= \begin{pmatrix} A & B-iC \\ B+iC & D \end{pmatrix} = \frac{A+D}{2} \begin{pmatrix} 1 & 0 \\ 0 & 1 \end{pmatrix} + \frac{A-D}{2} \begin{pmatrix} 1 & 0 \\ 0 & -1 \end{pmatrix} + B \begin{pmatrix} 0 & 1 \\ 1 & 0 \end{pmatrix} + C \begin{pmatrix} 0 & -i \\ i & 0 \end{pmatrix} && \text{Notation for } 2D \text{ Spinor space} \\
 &= \omega_0 \sigma_0 + \omega_A \sigma_A + \omega_B \sigma_B + \omega_C \sigma_C = \omega_0 \sigma_0 + \vec{\omega} \cdot \vec{\sigma} = \omega_0 \mathbf{1} + \omega \sigma_\omega \\
 &= \Omega_0 \mathbf{1} + \Omega_A \mathbf{S}_A + \Omega_B \mathbf{S}_B + \Omega_C \mathbf{S}_C = \Omega_0 \mathbf{1} + \vec{\Omega} \cdot \vec{\mathbf{S}} \\
 &= \frac{A+D}{2} \begin{pmatrix} 1 & 0 \\ 0 & 1 \end{pmatrix} + (A-D) \begin{pmatrix} \frac{1}{2} & 0 \\ 0 & -\frac{1}{2} \end{pmatrix} + 2B \begin{pmatrix} 0 & \frac{1}{2} \\ \frac{1}{2} & 0 \end{pmatrix} + 2C \begin{pmatrix} 0 & -\frac{i}{2} \\ \frac{i}{2} & 0 \end{pmatrix} && \text{Notation for } 3D \text{ Vector space} \\
 &\quad \text{0}^{\text{th}} \text{ component unchanged} \quad \text{components } A, B, C \text{ switch } 1/2\text{-factor from } \omega\text{-velocity to } S\text{-momentum}
 \end{aligned}$$

Symmetry archetypes: *A* (Asymmetric-diagonal) | *B* (Bilateral-balanced) | *C* (Chiral-circular-complex...)

The $\{\sigma_0, \sigma_A, \sigma_B, \sigma_C\}$ are the well known *Pauli-spin operators* $\{\sigma_0 = \sigma_0, \sigma_B = \sigma_X, \sigma_C = \sigma_Y, \sigma_A = \sigma_Z\}$

The $\{\mathbf{1}, \mathbf{S}_A, \mathbf{S}_B, \mathbf{S}_C\}$ are the *Jordan-Angular-Momentum operators* $\{\mathbf{1} = \sigma_0, \mathbf{S}_B = \mathbf{S}_X, \mathbf{S}_C = \mathbf{S}_Y, \mathbf{S}_A = \mathbf{S}_Z\}$
 (Often labeled $\{J_X, J_Y, J_Z\}$)

Notation for
2D Spinor space

where: $\vec{\phi} = \vec{\omega} \cdot t = \begin{pmatrix} \omega_A \\ \omega_B \\ \omega_C \end{pmatrix} \cdot t = \begin{pmatrix} \frac{A-D}{2} \\ B \\ C \end{pmatrix} \cdot t$ and: $\omega_0 = \frac{A+D}{2}$

$$e^{-i\mathbf{H}t} = e^{-i \begin{pmatrix} A & B-iC \\ B+iC & D \end{pmatrix} t} = e^{-i(\omega_0 \sigma_0 + \vec{\omega} \cdot \vec{\sigma})t} = e^{-i\omega_0 t} e^{-i \vec{\omega} \cdot \vec{\sigma} t} = e^{-i\omega_0 t} e^{-i \sigma_\omega \omega t} = e^{-i\omega_0 t} (\mathbf{1} \cos \omega t - i \sigma_\omega \sin \omega t)$$

The "mysterious" factors of 2 (or 1/2): 2D Spinor vs 3D Spin Vector space

$$\begin{aligned}
 \mathbf{H} &= \begin{pmatrix} A & B-iC \\ B+iC & D \end{pmatrix} = \frac{A+D}{2} \begin{pmatrix} 1 & 0 \\ 0 & 1 \end{pmatrix} + \frac{A-D}{2} \begin{pmatrix} 1 & 0 \\ 0 & -1 \end{pmatrix} + B \begin{pmatrix} 0 & 1 \\ 1 & 0 \end{pmatrix} + C \begin{pmatrix} 0 & -i \\ i & 0 \end{pmatrix} && \text{Notation for 2D Spinor space} \\
 &= \omega_0 \sigma_0 + \omega_A \sigma_A + \omega_B \sigma_B + \omega_C \sigma_C = \omega_0 \sigma_0 + \vec{\omega} \cdot \vec{\sigma} = \omega_0 \mathbf{1} + \omega \sigma_\omega \\
 &= \Omega_0 \mathbf{1} + \Omega_A \mathbf{S}_A + \Omega_B \mathbf{S}_B + \Omega_C \mathbf{S}_C = \Omega_0 \mathbf{1} + \vec{\Omega} \cdot \vec{\mathbf{S}} \\
 &= \frac{A+D}{2} \begin{pmatrix} 1 & 0 \\ 0 & 1 \end{pmatrix} + (A-D) \begin{pmatrix} \frac{1}{2} & 0 \\ 0 & -\frac{1}{2} \end{pmatrix} + 2B \begin{pmatrix} 0 & \frac{1}{2} \\ \frac{1}{2} & 0 \end{pmatrix} + 2C \begin{pmatrix} 0 & -\frac{i}{2} \\ \frac{i}{2} & 0 \end{pmatrix} && \text{Notation for 3D Vector space} \\
 &\quad \text{\small } 0^{\text{th}} \text{ component unchanged} \quad \text{\small components } A, B, C \text{ switch } 1/2\text{-factor from } \omega\text{-velocity to } S\text{-momentum}
 \end{aligned}$$

Symmetry archetypes: A (Asymmetric[↑]diagonal) | B (Bilateral[↑]balanced) | C (Chiral[↑]circular-complex...)

The $\{\sigma_0, \sigma_A, \sigma_B, \sigma_C\}$ are the well known *Pauli-spin operators* $\{\sigma_0 = \sigma_0, \sigma_B = \sigma_X, \sigma_C = \sigma_Y, \sigma_A = \sigma_Z\}$

The $\{\mathbf{1}, \mathbf{S}_A, \mathbf{S}_B, \mathbf{S}_C\}$ are the *Jordan-Angular-Momentum operators* $\{\mathbf{1} = \sigma_0, \mathbf{S}_B = \mathbf{S}_X, \mathbf{S}_C = \mathbf{S}_Y, \mathbf{S}_A = \mathbf{S}_Z\}$
(Often labeled $\{\mathbf{J}_X, \mathbf{J}_Y, \mathbf{J}_Z\}$)

Notation for
2D Spinor space

$$\text{where: } \vec{\phi} = \vec{\omega} \cdot t = \begin{pmatrix} \omega_A \\ \omega_B \\ \omega_C \end{pmatrix} \cdot t = \begin{pmatrix} \frac{A-D}{2} \\ B \\ C \end{pmatrix} \cdot t \text{ and: } \omega_0 = \frac{A+D}{2}$$

$$\begin{aligned}
 e^{-i\mathbf{H}t} &= e^{-i \begin{pmatrix} A & B-iC \\ B+iC & D \end{pmatrix} t} = e^{-i(\omega_0 \sigma_0 + \vec{\omega} \cdot \vec{\sigma})t} = e^{-i\omega_0 t} e^{-i \vec{\omega} \cdot \vec{\sigma} t} = e^{-i\omega_0 t} e^{-i \sigma_\omega \omega t} = e^{-i\omega_0 t} \left(\mathbf{1} \cos \omega t - i \sigma_\omega \sin \omega t \right) \\
 &= e^{-i(\Omega_0 \mathbf{1} + \vec{\Omega} \cdot \vec{\mathbf{S}})t} = e^{-i\Omega_0 t} e^{-i \vec{\Omega} \cdot \vec{\mathbf{S}} t} = e^{-i\Omega_0 t} \left(\mathbf{1} \cos \frac{\Omega t}{2} - i \sigma_\omega \sin \frac{\Omega t}{2} \right)
 \end{aligned}$$

Notation for
3D Vector space

$$\text{where: } \vec{\Theta} = \vec{\Omega} \cdot t = \begin{pmatrix} \Omega_A \\ \Omega_B \\ \Omega_C \end{pmatrix} \cdot t = \begin{pmatrix} A-D \\ 2B \\ 2C \end{pmatrix} \cdot t \text{ and: } \Omega_0 = \frac{A+D}{2}$$

The "mysterious" factors of 2 (or 1/2): 2D Spinor vs 3D Spin Vector space

$$\begin{aligned}
 \mathbf{H} &= \begin{pmatrix} A & B-iC \\ B+iC & D \end{pmatrix} = \frac{A+D}{2} \begin{pmatrix} 1 & 0 \\ 0 & 1 \end{pmatrix} + \frac{A-D}{2} \begin{pmatrix} 1 & 0 \\ 0 & -1 \end{pmatrix} + B \begin{pmatrix} 0 & 1 \\ 1 & 0 \end{pmatrix} + C \begin{pmatrix} 0 & -i \\ i & 0 \end{pmatrix} && \text{Notation for 2D Spinor space} \\
 &= \omega_0 \sigma_0 + \omega_A \sigma_A + \omega_B \sigma_B + \omega_C \sigma_C = \omega_0 \sigma_0 + \vec{\omega} \cdot \vec{\sigma} = \omega_0 \mathbf{1} + \omega \sigma_\omega \\
 &= \Omega_0 \mathbf{1} + \Omega_A \mathbf{S}_A + \Omega_B \mathbf{S}_B + \Omega_C \mathbf{S}_C = \Omega_0 \mathbf{1} + \vec{\Omega} \cdot \vec{\mathbf{S}} \\
 &= \frac{A+D}{2} \begin{pmatrix} 1 & 0 \\ 0 & 1 \end{pmatrix} + (A-D) \begin{pmatrix} \frac{1}{2} & 0 \\ 0 & -\frac{1}{2} \end{pmatrix} + 2B \begin{pmatrix} 0 & \frac{1}{2} \\ \frac{1}{2} & 0 \end{pmatrix} + 2C \begin{pmatrix} 0 & -\frac{i}{2} \\ \frac{i}{2} & 0 \end{pmatrix} && \text{Notation for 3D Vector space} \\
 &\quad \text{0}^{\text{th}} \text{ component unchanged} \quad \text{components } A, B, C \text{ switch } 1/2\text{-factor from } \omega\text{-velocity to } S\text{-momentum}
 \end{aligned}$$

Symmetry archetypes: A (Asymmetric[↑]diagonal) | B (Bilateral[↑]balanced) | C (Chiral[↑]circular-complex...)

"Crank" vector

The $\{\sigma_0, \sigma_A, \sigma_B, \sigma_C\}$ are the well known *Pauli-spin operators* $\{\sigma_0 = \sigma_0, \sigma_B = \sigma_X, \sigma_C = \sigma_Y, \sigma_A = \sigma_Z\}$

The $\{\mathbf{1}, \mathbf{S}_A, \mathbf{S}_B, \mathbf{S}_C\}$ are the *Jordan-Angular-Momentum operators* $\{\mathbf{1} = \sigma_0, \mathbf{S}_B = \mathbf{S}_X, \mathbf{S}_C = \mathbf{S}_Y, \mathbf{S}_A = \mathbf{S}_Z\}$

(Often labeled $\{J_X, J_Y, J_Z\}$)

$$\vec{\varphi} = \begin{pmatrix} \varphi_A \\ \varphi_B \\ \varphi_C \end{pmatrix} = \vec{\omega} \cdot t = \begin{pmatrix} \omega_A \\ \omega_B \\ \omega_C \end{pmatrix} \cdot t = \begin{pmatrix} \frac{A-D}{2} \\ B \\ C \end{pmatrix} \cdot t$$

Notation for 2D Spinor space

$$\text{where: } \vec{\varphi} = \vec{\omega} \cdot t = \begin{pmatrix} \omega_A \\ \omega_B \\ \omega_C \end{pmatrix} \cdot t = \begin{pmatrix} \frac{A-D}{2} \\ B \\ C \end{pmatrix} \cdot t \text{ and: } \omega_0 = \frac{A+D}{2}$$

$$e^{-i\mathbf{H}t} = e^{-i \begin{pmatrix} A & B-iC \\ B+iC & D \end{pmatrix} t} = e^{-i(\omega_0 \sigma_0 + \vec{\omega} \cdot \vec{\sigma})t} = e^{-i\omega_0 t} e^{-i \vec{\omega} \cdot \vec{\sigma} t} = e^{-i\omega_0 t} e^{-i \sigma_\omega \omega t} = e^{-i\omega_0 t} (\mathbf{1} \cos \omega t - i \sigma_\omega \sin \omega t)$$

"Crank" vector

$$= e^{-i(\Omega_0 \mathbf{1} + \vec{\Omega} \cdot \vec{\mathbf{S}})t} = e^{-i\Omega_0 t} e^{-i \vec{\Omega} \cdot \vec{\mathbf{S}} t} = e^{-i\Omega_0 t} \left(\mathbf{1} \cos \frac{\Omega t}{2} - i \sigma_\omega \sin \frac{\Omega t}{2} \right)$$

Notation for 3D Vector space

$$\text{where: } \vec{\Theta} = \vec{\Omega} \cdot t = \begin{pmatrix} \Omega_A \\ \Omega_B \\ \Omega_C \end{pmatrix} \cdot t = \begin{pmatrix} A-D \\ 2B \\ 2C \end{pmatrix} \cdot t \text{ and: } \Omega_0 = \frac{A+D}{2}$$

*ANALOGY: 2-State Schrodinger: $i\hbar\partial_t|\Psi(t)\rangle = \mathbf{H}|\Psi(t)\rangle$ versus Classical 2D-HO: $\partial_t^2\mathbf{x} = -\mathbf{K}\cdot\mathbf{x}$
Hamilton-Pauli spinor symmetry (σ -expansion in *ABCD*-Types) $\mathbf{H} = \omega_\mu \boldsymbol{\sigma}_\mu$*

Derive σ -exponential time evolution (or revolution) operator $\mathbf{U} = e^{-i\mathbf{H}t} = e^{-i\boldsymbol{\sigma}_\mu \omega_\mu t}$

Spinor arithmetic like complex arithmetic

Spinor vector algebra like complex vector algebra

Spinor exponentials like complex exponentials

Geometry of evolution (or revolution) operator $\mathbf{U} = e^{-i\mathbf{H}t} = e^{-i\boldsymbol{\sigma}_\mu \omega_\mu t}$

The “mysterious” factors of 2 (or 1/2): 2D Spinor vs 3D Spin Vector space

➔ 2D Spinor vs 3D vector rotation

NMR Hamiltonian: 3D Spin Moment \mathbf{m} in \mathbf{B} field

The "mysterious" factors of 2 (or 1/2): 2D Spinor vs 3D Spin Vector space

$U(2)$: 2D Spinor $\{|\uparrow\rangle, |\downarrow\rangle\}$ -space (complex)

$R(3)$: 3D Spin Vector $\{S_X, S_Y, S_Z\}$ -space (real)

State vector $|\Psi\rangle = |\uparrow\rangle\langle\uparrow|\Psi\rangle + |\downarrow\rangle\langle\downarrow|\Psi\rangle$

Spin vector $\mathbf{S} = |X\rangle\langle X|\mathbf{S}\rangle + |Y\rangle\langle Y|\mathbf{S}\rangle + |Z\rangle\langle Z|\mathbf{S}\rangle$

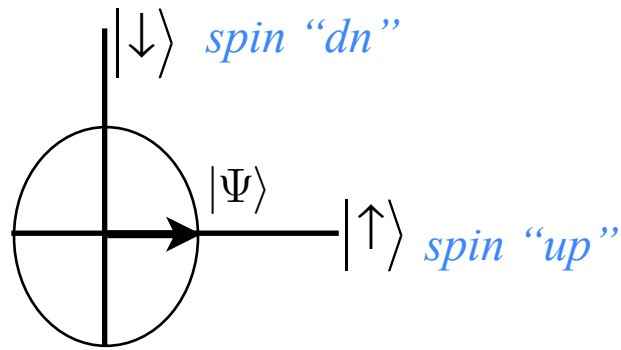

$$\begin{pmatrix} \Psi_{\uparrow} \\ \Psi_{\downarrow} \end{pmatrix} = \begin{pmatrix} 1 \\ 0 \end{pmatrix}$$

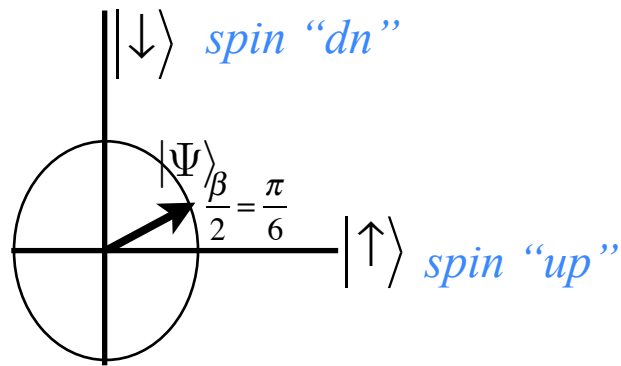

$$\begin{pmatrix} \Psi_{\uparrow} \\ \Psi_{\downarrow} \end{pmatrix} = \begin{pmatrix} \cos \frac{\beta}{2} & -\sin \frac{\beta}{2} \\ \sin \frac{\beta}{2} & \cos \frac{\beta}{2} \end{pmatrix} \begin{pmatrix} 1 \\ 0 \end{pmatrix} = \begin{pmatrix} \cos \frac{\beta}{2} \\ \sin \frac{\beta}{2} \end{pmatrix} = \begin{pmatrix} \frac{\sqrt{3}}{2} \\ \frac{1}{2} \end{pmatrix}$$

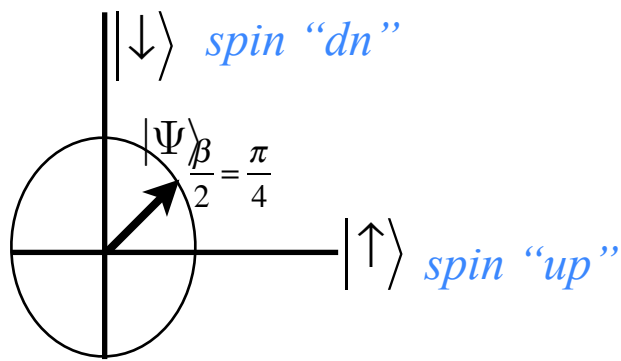

$$\begin{pmatrix} \Psi_{\uparrow} \\ \Psi_{\downarrow} \end{pmatrix} = \begin{pmatrix} \cos \frac{\beta}{2} \\ \sin \frac{\beta}{2} \end{pmatrix} = \begin{pmatrix} \frac{1}{\sqrt{2}} \\ \frac{1}{\sqrt{2}} \end{pmatrix}$$

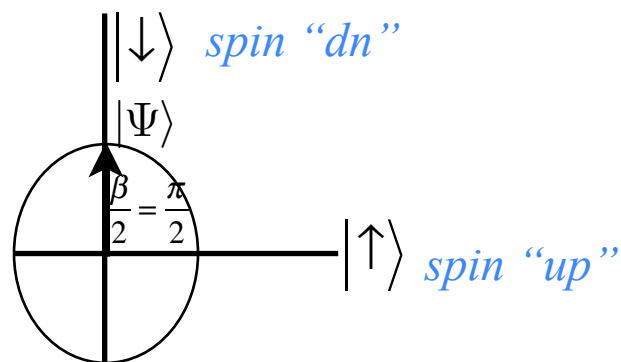

$$\begin{pmatrix} \Psi_{\uparrow} \\ \Psi_{\downarrow} \end{pmatrix} = \begin{pmatrix} \cos \frac{\beta}{2} \\ \sin \frac{\beta}{2} \end{pmatrix} = \begin{pmatrix} 0 \\ 1 \end{pmatrix}$$

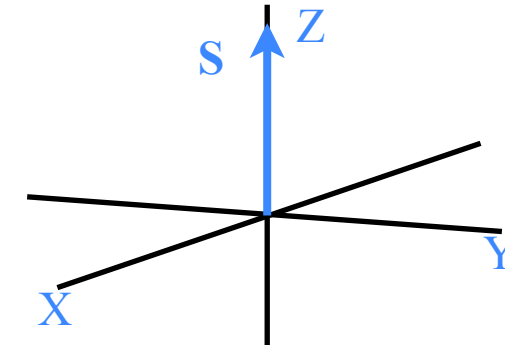

$$\begin{pmatrix} S_X \\ S_Y \\ S_Z \end{pmatrix} = \begin{pmatrix} 0 \\ 0 \\ 1 \end{pmatrix}$$

$$\begin{pmatrix} S_X \\ S_Y \\ S_Z \end{pmatrix} = \begin{pmatrix} \cos \beta & 0 & \sin \beta \\ 0 & 1 & 0 \\ -\sin \beta & 0 & \cos \beta \end{pmatrix} \begin{pmatrix} 0 \\ 0 \\ 1 \end{pmatrix}$$

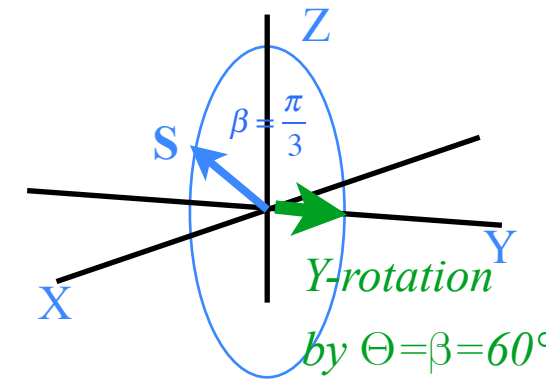

$$\begin{pmatrix} S_X \\ S_Y \\ S_Z \end{pmatrix} = \begin{pmatrix} \sin \beta \\ 0 \\ \cos \beta \end{pmatrix} = \begin{pmatrix} \sqrt{3}/2 \\ 0 \\ 1/2 \end{pmatrix}$$

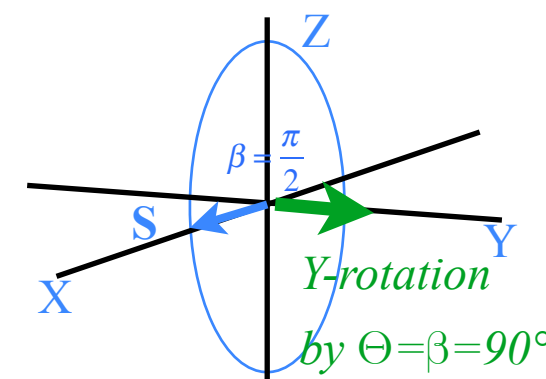

$$\begin{pmatrix} S_X \\ S_Y \\ S_Z \end{pmatrix} = \begin{pmatrix} \sin \beta \\ 0 \\ \cos \beta \end{pmatrix} = \begin{pmatrix} 1 \\ 0 \\ 0 \end{pmatrix}$$

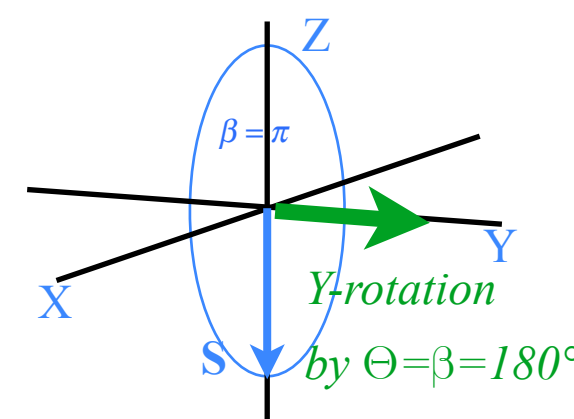

$$\begin{pmatrix} S_X \\ S_Y \\ S_Z \end{pmatrix} = \begin{pmatrix} \sin \beta \\ 0 \\ \cos \beta \end{pmatrix} = \begin{pmatrix} 0 \\ 0 \\ -1 \end{pmatrix}$$

Life in 2D Spinor space is "Half-Fast"

The "mysterious" factors of 2 (or 1/2): 2D Spinor vs 3D Spin Vector space

$U(2)$: 2D Spinor $\{|\uparrow\rangle, |\downarrow\rangle\}$ -space (complex)

$R(3)$: 3D Spin Vector $\{S_X, S_Y, S_Z\}$ -space (real)

State vector $|\Psi\rangle = |\uparrow\rangle\langle\uparrow|\Psi\rangle + |\downarrow\rangle\langle\downarrow|\Psi\rangle$

Spin vector $\mathbf{S} = |X\rangle\langle X|\mathbf{S}\rangle + |Y\rangle\langle Y|\mathbf{S}\rangle + |Z\rangle\langle Z|\mathbf{S}\rangle$

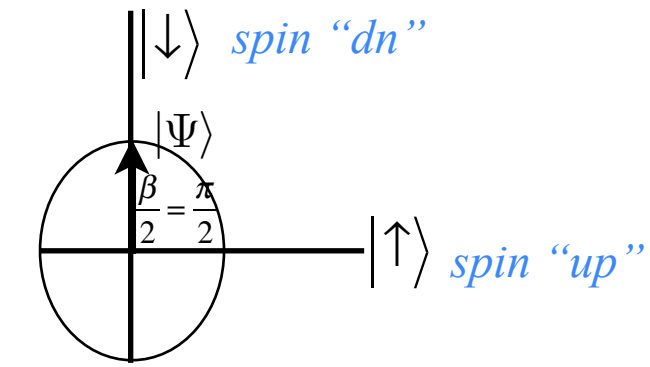

$$\begin{pmatrix} \Psi_{\uparrow} \\ \Psi_{\downarrow} \end{pmatrix} = \begin{pmatrix} \cos \frac{\beta}{2} \\ \sin \frac{\beta}{2} \end{pmatrix} = \begin{pmatrix} 0 \\ 1 \end{pmatrix}$$

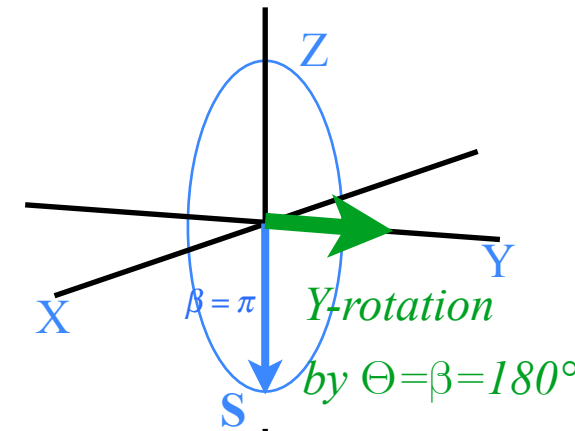

$$\begin{pmatrix} S_X \\ S_Y \\ S_Z \end{pmatrix} = \begin{pmatrix} \sin \beta \\ 0 \\ \cos \beta \end{pmatrix} = \begin{pmatrix} 0 \\ 0 \\ -1 \end{pmatrix}$$

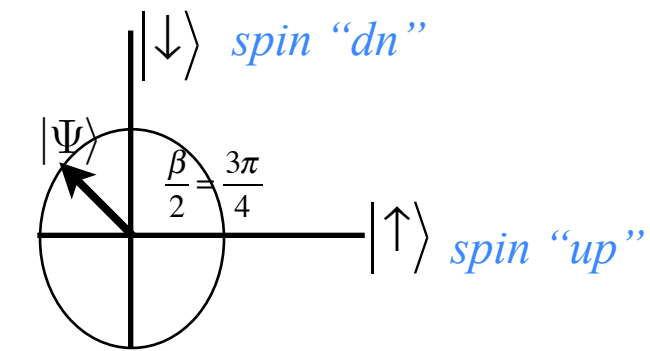

$$\begin{pmatrix} \Psi_{\uparrow} \\ \Psi_{\downarrow} \end{pmatrix} = \begin{pmatrix} \cos \frac{\beta}{2} \\ \sin \frac{\beta}{2} \end{pmatrix} = \begin{pmatrix} -\frac{1}{\sqrt{2}} \\ \frac{1}{\sqrt{2}} \end{pmatrix}$$

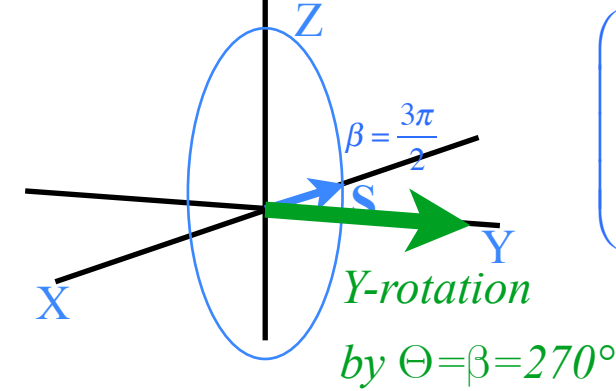

$$\begin{pmatrix} S_X \\ S_Y \\ S_Z \end{pmatrix} = \begin{pmatrix} \sin \beta \\ 0 \\ \cos \beta \end{pmatrix} = \begin{pmatrix} -1 \\ 0 \\ 0 \end{pmatrix}$$

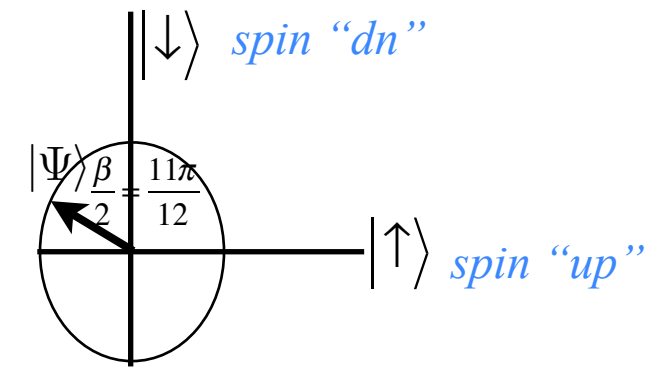

$$\begin{pmatrix} \Psi_{\uparrow} \\ \Psi_{\downarrow} \end{pmatrix} = \begin{pmatrix} \cos \frac{\beta}{2} \\ \sin \frac{\beta}{2} \end{pmatrix} = \begin{pmatrix} -\frac{\sqrt{3}}{2} \\ \frac{1}{2} \end{pmatrix}$$

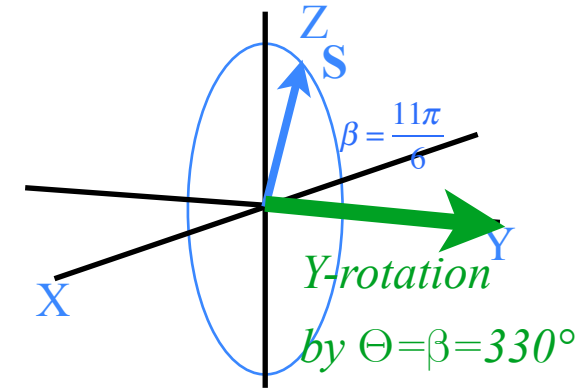

$$\begin{pmatrix} S_X \\ S_Y \\ S_Z \end{pmatrix} = \begin{pmatrix} \sin \beta \\ 0 \\ \cos \beta \end{pmatrix} =$$

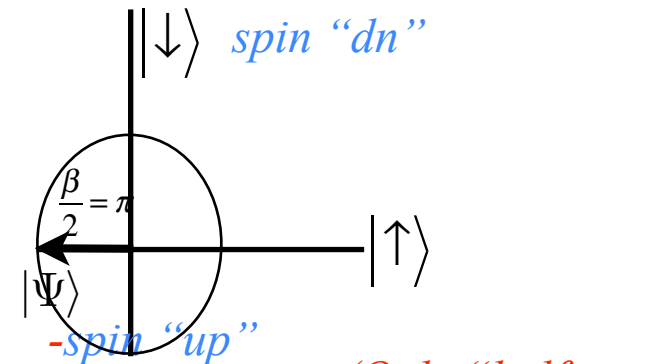

$$\begin{pmatrix} \Psi_{\uparrow} \\ \Psi_{\downarrow} \end{pmatrix} = \begin{pmatrix} \cos \frac{\beta}{2} \\ \sin \frac{\beta}{2} \end{pmatrix} = \begin{pmatrix} -1 \\ 0 \end{pmatrix}$$

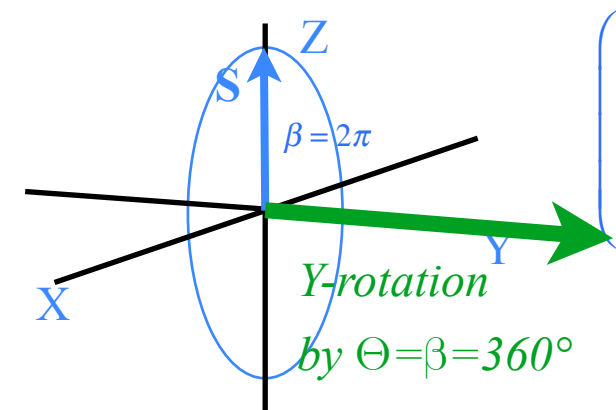

$$\begin{pmatrix} S_X \\ S_Y \\ S_Z \end{pmatrix} = \begin{pmatrix} 1 \\ 0 \\ 0 \end{pmatrix}$$

with π -phase (Only "half-way" home after $2\pi = 360^\circ$ rotation)

Life in 2D Spinor space is "Half-Fast" and needs $\Theta = 4\pi = 720^\circ$ to return to original state

*ANALOGY: 2-State Schrodinger: $i\hbar\partial_t|\Psi(t)\rangle = \mathbf{H}|\Psi(t)\rangle$ versus Classical 2D-HO: $\partial_t^2\mathbf{x} = -\mathbf{K}\cdot\mathbf{x}$
Hamilton-Pauli spinor symmetry (σ -expansion in *ABCD*-Types) $\mathbf{H} = \omega_\mu \boldsymbol{\sigma}_\mu$*

Derive σ -exponential time evolution (or revolution) operator $\mathbf{U} = e^{-i\mathbf{H}t} = e^{-i\boldsymbol{\sigma}_\mu \omega_\mu t}$

Spinor arithmetic like complex arithmetic

Spinor vector algebra like complex vector algebra

Spinor exponentials like complex exponentials

Geometry of evolution (or revolution) operator $\mathbf{U} = e^{-i\mathbf{H}t} = e^{-i\boldsymbol{\sigma}_\mu \omega_\mu t}$

The “mysterious” factors of 2 (or 1/2): 2D Spinor vs 3D Spin Vector space

2D Spinor vs 3D vector rotation

➔ NMR Hamiltonian: 3D Spin Moment \mathbf{m} in \mathbf{B} field

Hamiltonian for NMR: 3D Spin Moment Vector $\mathbf{m}=(m_x, m_y, m_z)$ in field $\mathbf{B}=(B_x, B_y, B_z)$

$$\mathbf{H}=\mathbf{m}\cdot\mathbf{B}=g\boldsymbol{\sigma}\cdot\mathbf{B}=\begin{pmatrix} gB_Z & gB_X-igB_Y \\ gB_X+igB_Y & -gB_Z \end{pmatrix}=gB_Z\begin{pmatrix} 1 & 0 \\ 0 & -1 \end{pmatrix}+gB_X\begin{pmatrix} 0 & 1 \\ 1 & 0 \end{pmatrix}+gB_Y\begin{pmatrix} 0 & -i \\ i & 0 \end{pmatrix}$$

$$=gB_Z\boldsymbol{\sigma}_A+gB_X\boldsymbol{\sigma}_X+gB_Y\boldsymbol{\sigma}_Y=\vec{\omega}\cdot\vec{\sigma}=\omega\boldsymbol{\sigma}_\omega$$

Notation for
2D Spinor space

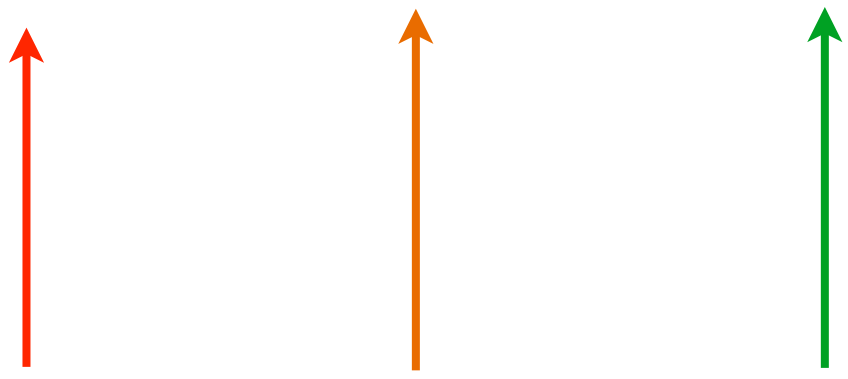

Symmetry archetypes: *A (Asymmetric-diagonal)* | *B (Bilateral-balanced)* | *C (Chiral-circular-complex...)*

The $\{\boldsymbol{\sigma}_I, \boldsymbol{\sigma}_A, \boldsymbol{\sigma}_B, \boldsymbol{\sigma}_C\}$ are the well known *Pauli-spin operators* $\{\boldsymbol{\sigma}_I=\boldsymbol{\sigma}_0, \boldsymbol{\sigma}_B=\boldsymbol{\sigma}_X, \boldsymbol{\sigma}_C=\boldsymbol{\sigma}_Y, \boldsymbol{\sigma}_A=\boldsymbol{\sigma}_Z\}$

Hamiltonian for NMR: 3D Spin Moment Vector $\mathbf{m}=(m_x, m_y, m_z)$ in field $\mathbf{B}=(B_x, B_y, B_z)$

$$\mathbf{H}=\mathbf{m}\cdot\mathbf{B}=g\boldsymbol{\sigma}\cdot\mathbf{B}=\begin{pmatrix} gB_Z & gB_X-igB_Y \\ gB_X+igB_Y & -gB_Z \end{pmatrix}=gB_Z\begin{pmatrix} 1 & 0 \\ 0 & -1 \end{pmatrix}+gB_X\begin{pmatrix} 0 & 1 \\ 1 & 0 \end{pmatrix}+gB_Y\begin{pmatrix} 0 & -i \\ i & 0 \end{pmatrix}$$

$$=gB_Z\boldsymbol{\sigma}_A+gB_X\boldsymbol{\sigma}_X+gB_Y\boldsymbol{\sigma}_Y=\vec{\omega}\cdot\vec{\sigma}=\omega\boldsymbol{\sigma}_\omega$$

Notation for 2D Spinor space

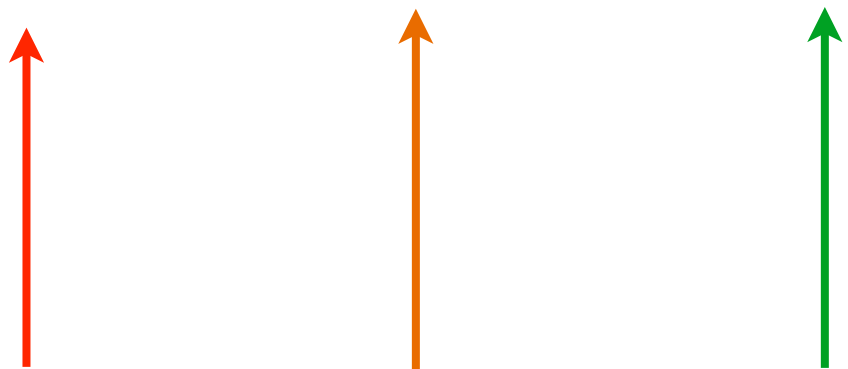

Symmetry archetypes: *A (Asymmetric-diagonal) | B (Bilateral-balanced) | C (Chiral-circular-complex...)*

The $\{\boldsymbol{\sigma}_I, \boldsymbol{\sigma}_A, \boldsymbol{\sigma}_B, \boldsymbol{\sigma}_C\}$ are the well known *Pauli-spin operators* $\{\boldsymbol{\sigma}_I=\boldsymbol{\sigma}_0, \boldsymbol{\sigma}_B=\boldsymbol{\sigma}_X, \boldsymbol{\sigma}_C=\boldsymbol{\sigma}_Y, \boldsymbol{\sigma}_A=\boldsymbol{\sigma}_Z\}$

Notation for 3D Vector space

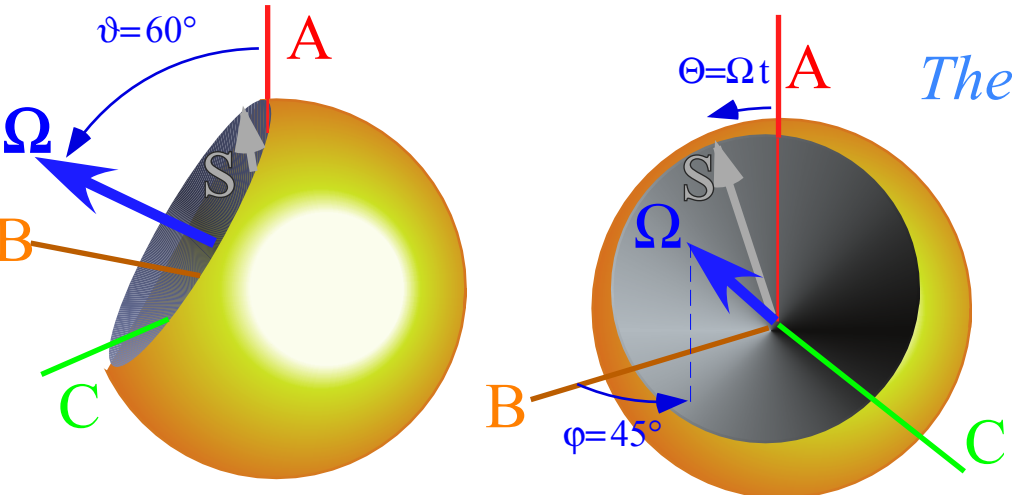

The driving $\Theta=\Omega t$ vector is defined by the *ABCD* of Hamiltonian \mathbf{H} .

The driven spin vector \mathbf{S} defines the state. But, how?

Fig. 3.4.2 Two views of Hamilton crank vector $\Omega(\phi, \theta)$ whirling Stokes state vector \mathbf{S} in *ABC*-space.

Euler's state definition using rotations $\mathbf{R}(\alpha, 0, 0)$, $\mathbf{R}(0, \beta, 0)$, and $\mathbf{R}(0, 0, \gamma)$

- ➔ *Spin-1 (3D-real vector) case*
- Spin-1/2 (2D-complex spinor) case*

Euler's state definition using rotations $\mathbf{R}(\alpha, 0, 0)$, $\mathbf{R}(0, \beta, 0)$, and $\mathbf{R}(0, 0, \gamma)$

Spin-1 (3D-real vector) case

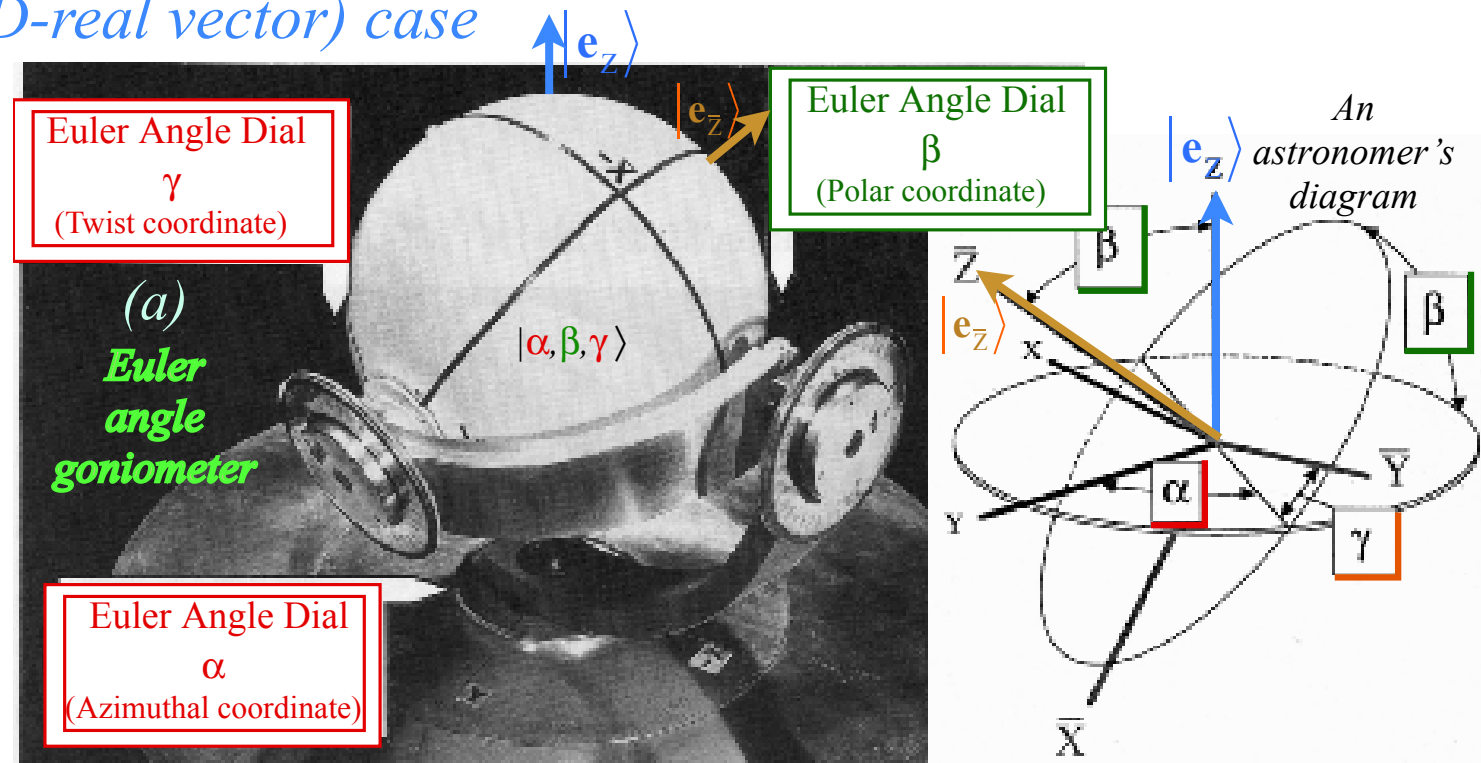

Euler Angle machine
discussed in CMwB Unit 6

See also Lects. 8-9
QTofCA Ch. 10A-B
Grp. Th. in QM 5093

[Under Construction!](#)
[Web based U\(2\) Calculator - Euler State](#)

Euler's rotation state definition using rotations $\mathbf{R}(\alpha, 0, 0)$, $\mathbf{R}(0, \beta, 0)$, and $\mathbf{R}(0, 0, \gamma)$

Spin-1 (3D-real vector) case

Third rotation $\mathbf{R}(\alpha 0 0)$

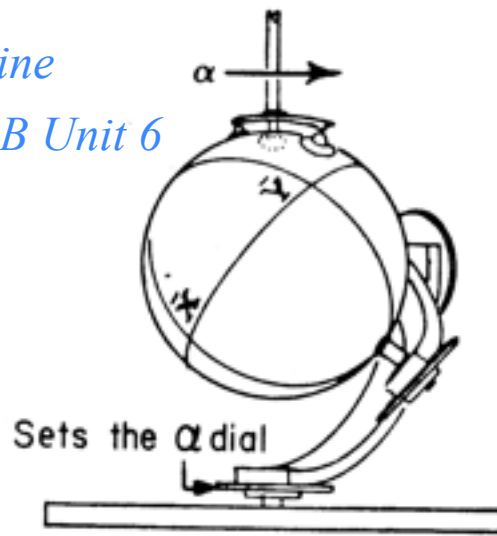

$$\langle R(\alpha\beta\gamma) \rangle = \langle R(\alpha 0 0) \rangle$$

Second rotation $\mathbf{R}(0\beta 0)$

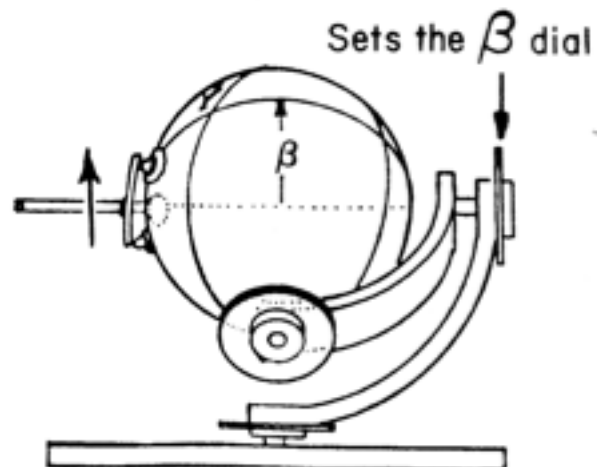

$$\langle R(0\beta 0) \rangle$$

First rotation $\mathbf{R}(0 0 \gamma)$

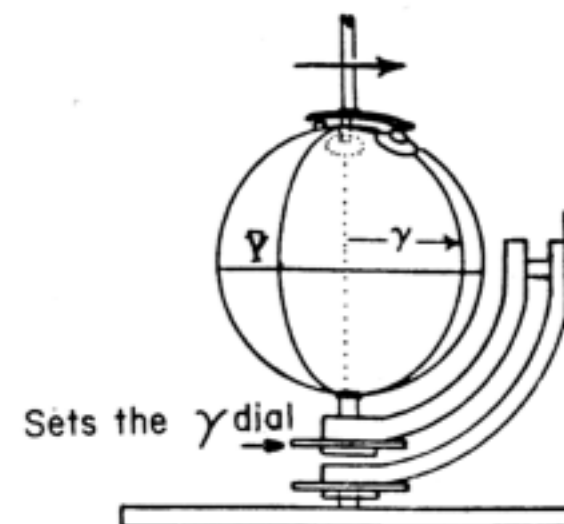

$$\langle R(0 0 \gamma) \rangle$$

Euler Angle machine
discussed in CMwB Unit 6

Euler's rotation state definition using rotations $\mathbf{R}(\alpha, 0, 0)$, $\mathbf{R}(0, \beta, 0)$, and $\mathbf{R}(0, 0, \gamma)$

Spin-1 (3D-real vector) case

Third rotation $\mathbf{R}(\alpha 0 0)$

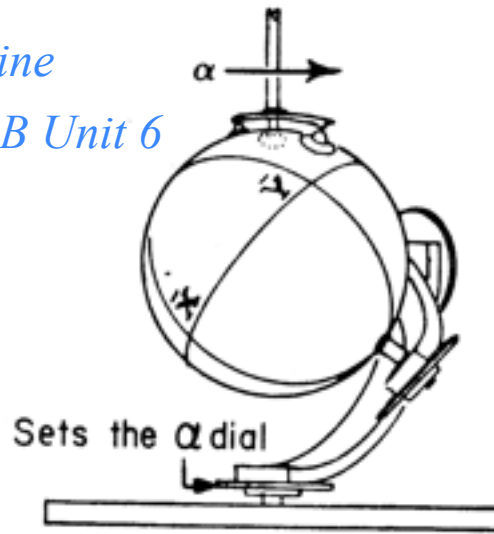

Second rotation $\mathbf{R}(0 \beta 0)$

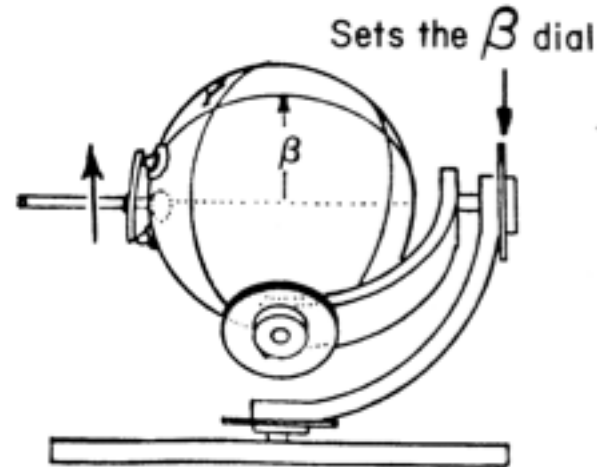

First rotation $\mathbf{R}(0 0 \gamma)$

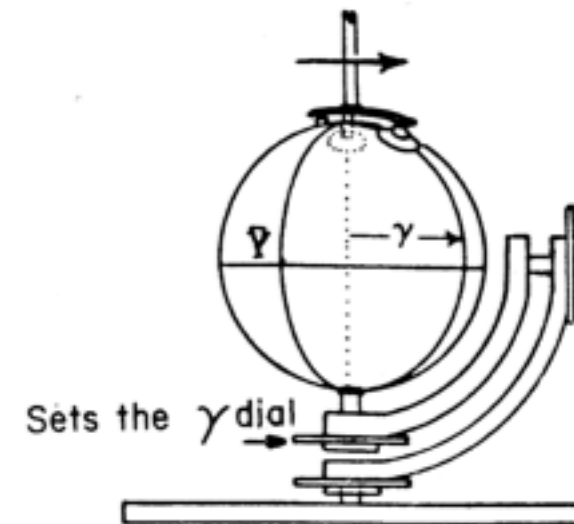

$$\langle R(\alpha\beta\gamma) \rangle = \langle R(\alpha 0 0) \rangle$$

$$\langle R(0\beta 0) \rangle$$

$$\langle R(0 0 \gamma) \rangle$$

$$= \begin{pmatrix} \cos\alpha & -\sin\alpha & 0 \\ \sin\alpha & \cos\alpha & 0 \\ 0 & 0 & 1 \end{pmatrix} \begin{pmatrix} \cos\beta & 0 & \sin\beta \\ 0 & 1 & 0 \\ -\sin\beta & 0 & \cos\beta \end{pmatrix} \begin{pmatrix} \cos\gamma & -\sin\gamma & 0 \\ \sin\gamma & \cos\gamma & 0 \\ 0 & 0 & 1 \end{pmatrix}$$

Euler's rotation state definition using rotations $\mathbf{R}(\alpha,0,0)$, $\mathbf{R}(0,\beta,0)$, and $\mathbf{R}(0,0,\gamma)$

Spin-1 (3D-real vector) case

Euler Angle machine
discussed in CMwB Unit 6

Third rotation $\mathbf{R}(\alpha 0 0)$

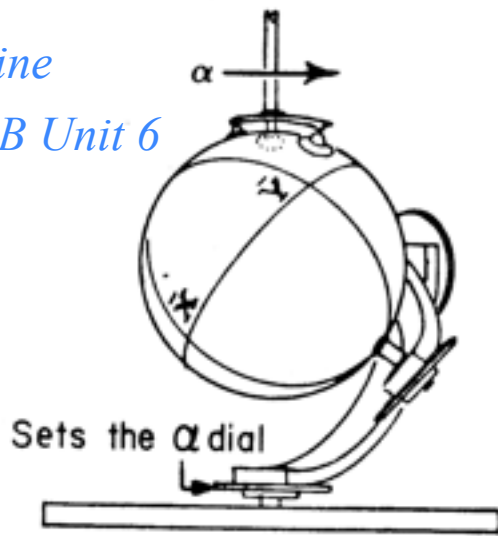

Second rotation $\mathbf{R}(0 \beta 0)$

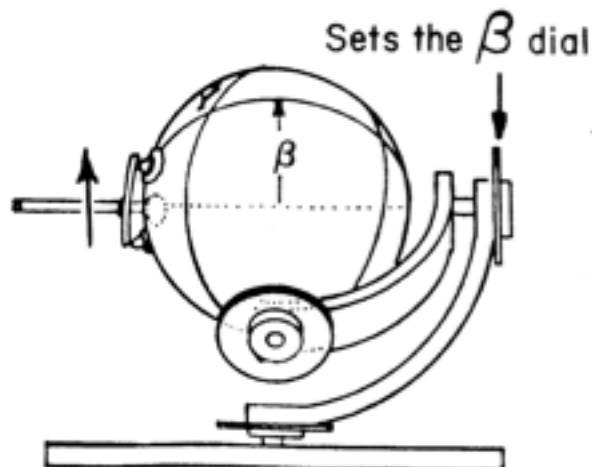

First rotation $\mathbf{R}(0 0 \gamma)$

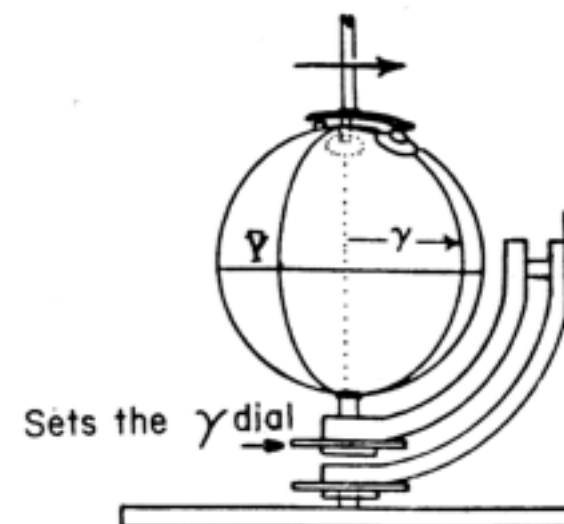

$$\langle R(\alpha\beta\gamma) \rangle = \langle R(\alpha 0 0) \rangle$$

$$\langle R(0\beta 0) \rangle$$

$$\langle R(0 0 \gamma) \rangle$$

$$= \begin{pmatrix} \cos\alpha & -\sin\alpha & 0 \\ \sin\alpha & \cos\alpha & 0 \\ 0 & 0 & 1 \end{pmatrix} \begin{pmatrix} \cos\beta & 0 & \sin\beta \\ 0 & 1 & 0 \\ -\sin\beta & 0 & \cos\beta \end{pmatrix} \begin{pmatrix} \cos\gamma & -\sin\gamma & 0 \\ \sin\gamma & \cos\gamma & 0 \\ 0 & 0 & 1 \end{pmatrix}$$

$$|\mathbf{e}_{\bar{x}}\rangle = R(\alpha\beta\gamma)|\mathbf{e}_x\rangle$$

$$|\mathbf{e}_{\bar{y}}\rangle = R(\alpha\beta\gamma)|\mathbf{e}_y\rangle$$

$$|\mathbf{e}_{\bar{z}}\rangle = R(\alpha\beta\gamma)|\mathbf{e}_z\rangle$$

$$\left(\begin{array}{l} \langle \mathbf{e}_x | \\ \langle \mathbf{e}_y | \\ \langle \mathbf{e}_z | \end{array} \middle| R(\alpha\beta\gamma) \middle| \begin{array}{l} \mathbf{e}_B \\ \mathbf{e}_B \\ \mathbf{e}_B \end{array} \right) = \begin{pmatrix} \cos\alpha \cos\beta \cos\gamma - \sin\alpha \sin\gamma & -\cos\alpha \cos\beta \sin\gamma - \sin\alpha \cos\gamma & \cos\alpha \sin\beta \\ \sin\alpha \cos\beta \cos\gamma + \cos\alpha \sin\gamma & -\sin\alpha \cos\beta \sin\gamma + \cos\alpha \cos\gamma & \sin\alpha \sin\beta \\ -\cos\gamma \sin\beta & \sin\gamma \sin\beta & \cos\beta \end{pmatrix}$$

Note lab-frame polar coordinates of Z-body vector $|\mathbf{e}_{\bar{z}}\rangle$

Euler's rotation state definition using rotations $\mathbf{R}(\alpha, 0, 0)$, $\mathbf{R}(0, \beta, 0)$, and $\mathbf{R}(0, 0, \gamma)$

Spin-1 (3D-real vector) case

Euler Angle machine
discussed in CMwB Unit 6

Third rotation $\mathbf{R}(\alpha 0 0)$

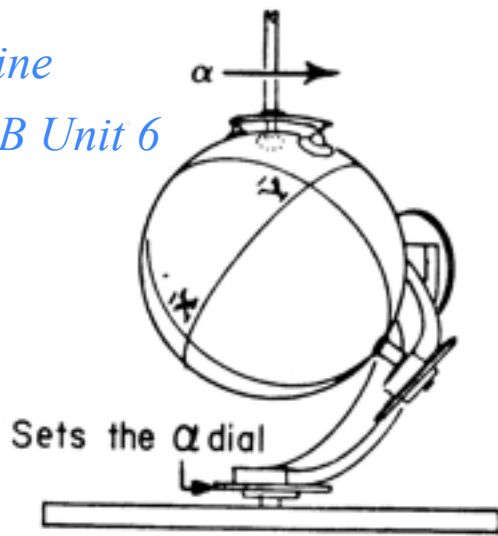

Second rotation $\mathbf{R}(0 \beta 0)$

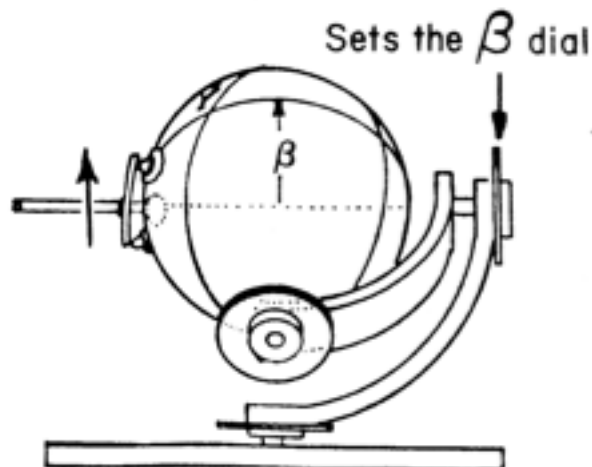

First rotation $\mathbf{R}(0 0 \gamma)$

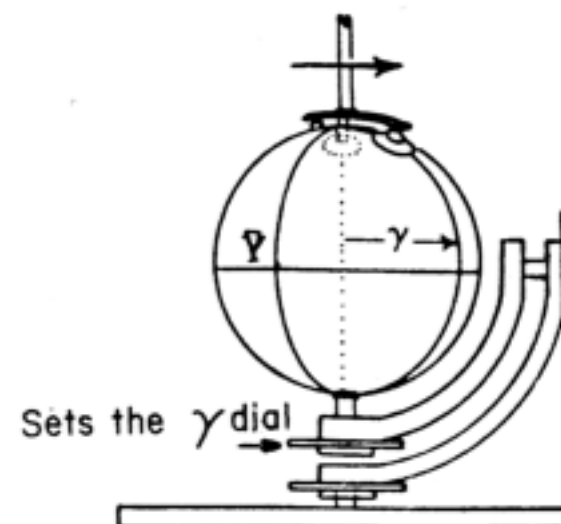

$$\langle R(\alpha\beta\gamma) \rangle = \langle R(\alpha 0 0) \rangle$$

$$\langle R(0\beta 0) \rangle$$

$$\langle R(0 0 \gamma) \rangle$$

$$= \begin{pmatrix} \cos\alpha & -\sin\alpha & 0 \\ \sin\alpha & \cos\alpha & 0 \\ 0 & 0 & 1 \end{pmatrix} \begin{pmatrix} \cos\beta & 0 & \sin\beta \\ 0 & 1 & 0 \\ -\sin\beta & 0 & \cos\beta \end{pmatrix} \begin{pmatrix} \cos\gamma & -\sin\gamma & 0 \\ \sin\gamma & \cos\gamma & 0 \\ 0 & 0 & 1 \end{pmatrix}$$

$$|\mathbf{e}_{\bar{x}}\rangle = R(\alpha\beta\gamma)|\mathbf{e}_x\rangle$$

$$|\mathbf{e}_{\bar{y}}\rangle = R(\alpha\beta\gamma)|\mathbf{e}_y\rangle$$

$$|\mathbf{e}_{\bar{z}}\rangle = R(\alpha\beta\gamma)|\mathbf{e}_z\rangle$$

$$\left(\begin{array}{l} \langle \mathbf{e}_x | \\ \langle \mathbf{e}_y | \\ \langle \mathbf{e}_z | \end{array} \middle| R(\alpha\beta\gamma) \middle| \begin{array}{l} \mathbf{e}_x \\ \mathbf{e}_y \\ \mathbf{e}_z \end{array} \right) = \begin{pmatrix} \cos\alpha \cos\beta \cos\gamma - \sin\alpha \sin\gamma & -\cos\alpha \cos\beta \sin\gamma - \sin\alpha \cos\gamma & \cos\alpha \sin\beta \\ \sin\alpha \cos\beta \cos\gamma + \cos\alpha \sin\gamma & -\sin\alpha \cos\beta \sin\gamma + \cos\alpha \cos\gamma & \sin\alpha \sin\beta \\ -\cos\gamma \sin\beta & \sin\gamma \sin\beta & \cos\beta \end{pmatrix}$$

Note lab-frame polar coordinates of Z-body vector $|\mathbf{e}_{\bar{z}}\rangle$

...and body-frame polar coordinates of Z-lab $|\mathbf{e}_z\rangle$

Euler Angle machine
discussed in CMwB Unit 6

See also Lects. 8-9
QTofCA Ch. 10A-B
Grp. Th. in QM 5093

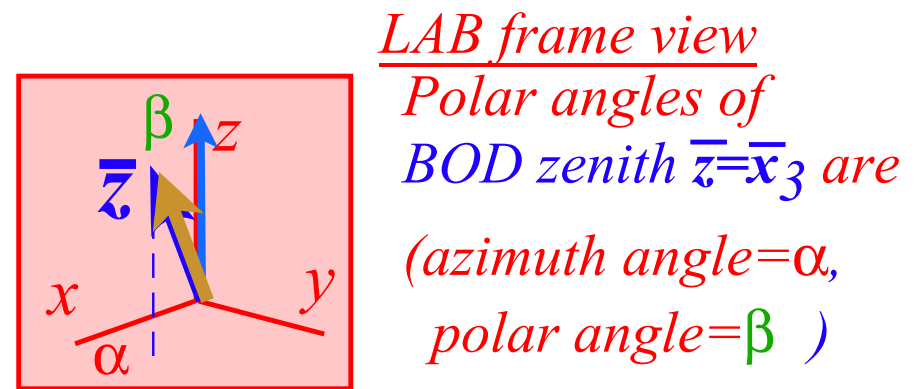
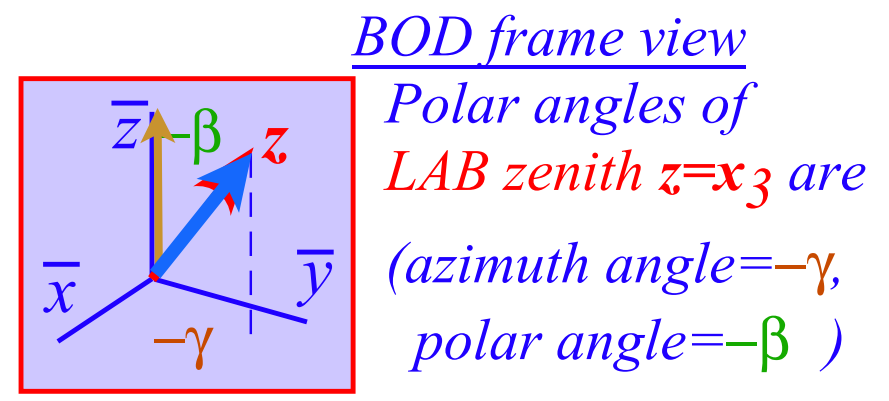
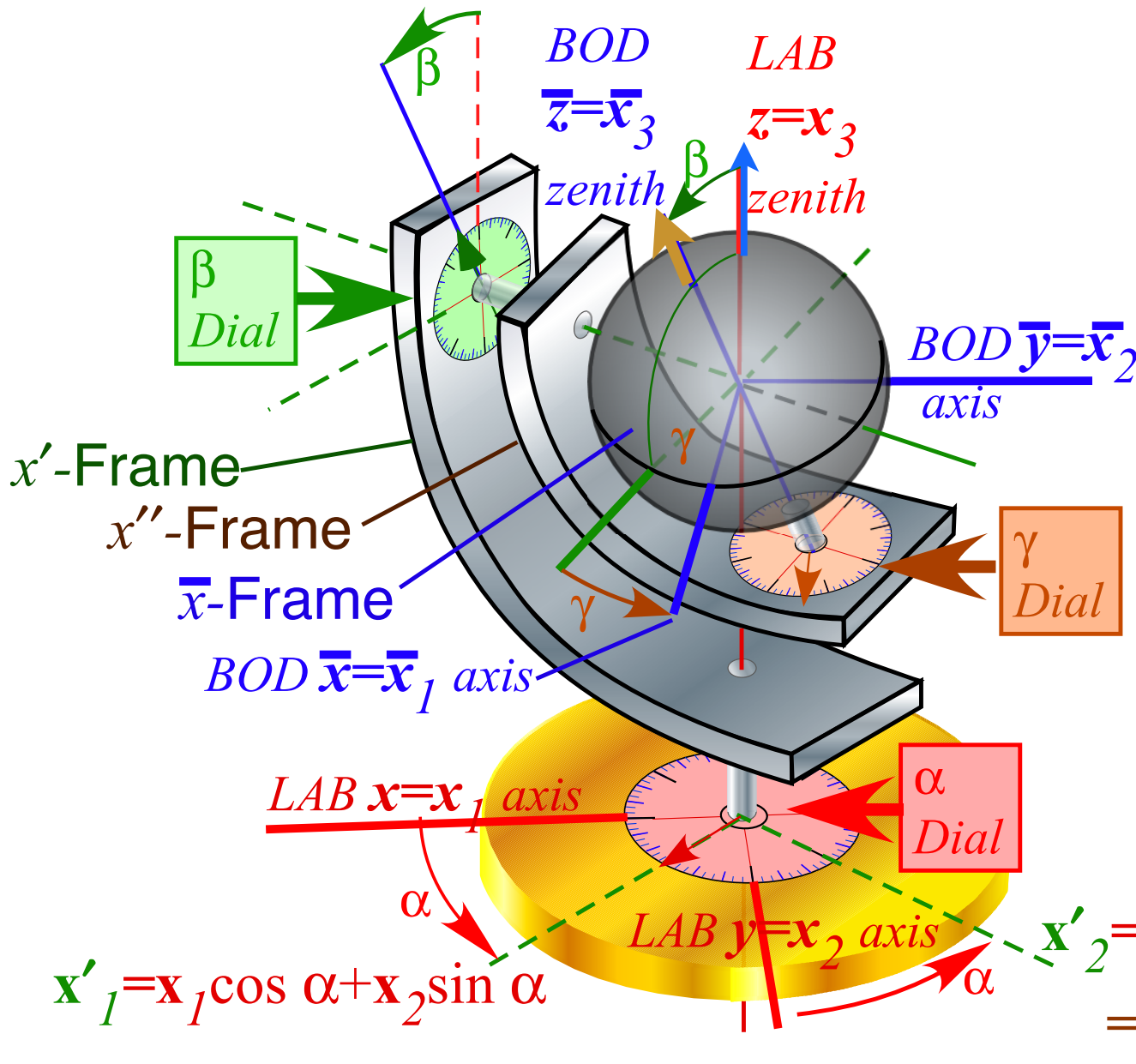
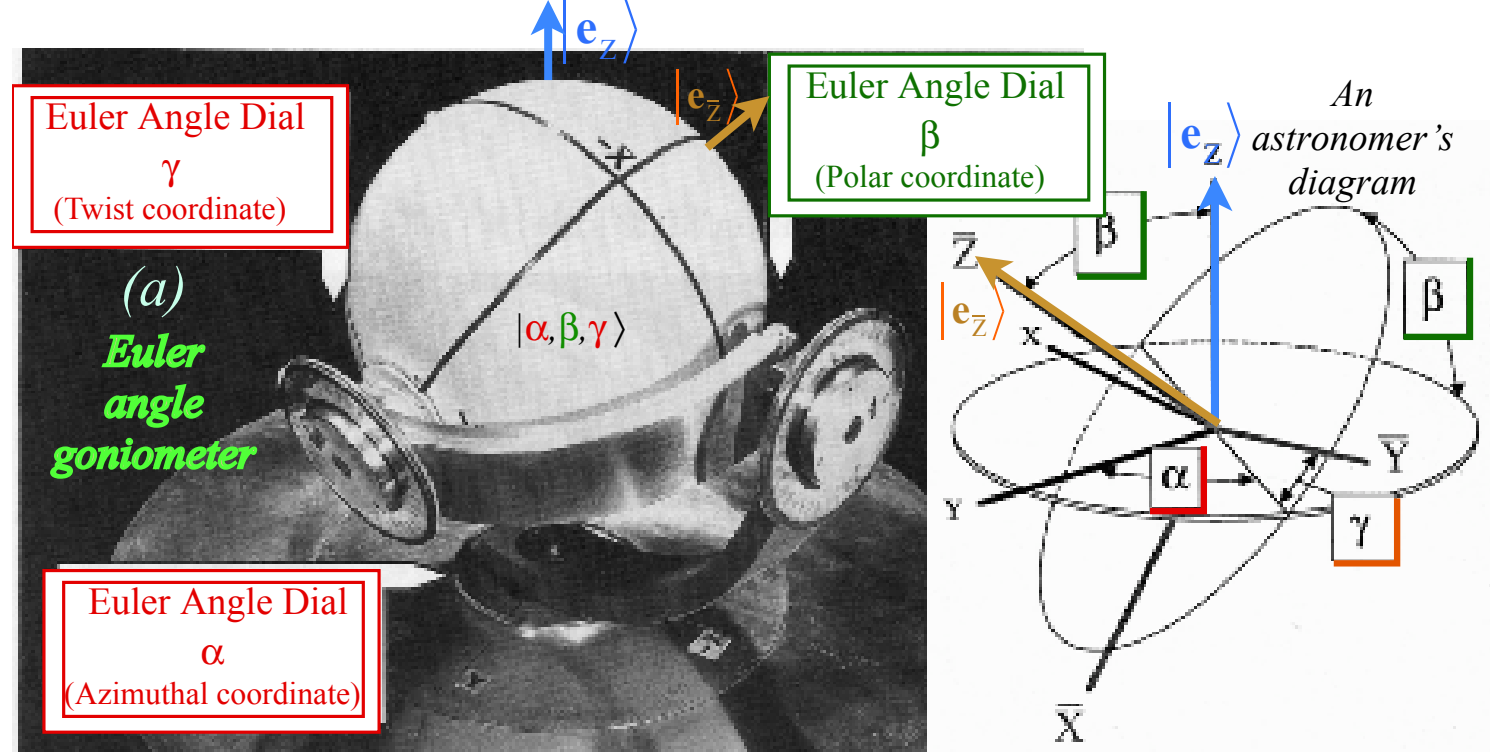

$$\mathbf{x}'_1 = \mathbf{x}_1 \cos \alpha + \mathbf{x}_2 \sin \alpha$$

$$\mathbf{x}'_2 = -\mathbf{x}_1 \sin \alpha + \mathbf{x}_2 \cos \alpha$$

$$= \bar{\mathbf{x}}_1 \sin \gamma + \bar{\mathbf{x}}_2 \cos \gamma$$

Euler's state definition using rotations $\mathbf{R}(\alpha, 0, 0)$, $\mathbf{R}(0, \beta, 0)$, and $\mathbf{R}(0, 0, \gamma)$

Spin-1 (3D-real vector) case

➔ *Spin-1/2 (2D-complex spinor) case*

Euler's rotation state definition using rotations $\mathbf{R}(\alpha, 0, 0)$, $\mathbf{R}(0, \beta, 0)$, and $\mathbf{R}(0, 0, \gamma)$

Spin-1/2 (2D-complex spinor) case

$$\begin{aligned}
 |a\rangle &= \mathbf{R}(\alpha\beta\gamma)|\uparrow\rangle \\
 &= \mathbf{R}[\alpha \text{ about } Z] \cdot \mathbf{R}[\beta \text{ about } Y] \cdot \mathbf{R}[\gamma \text{ about } Z]|\uparrow\rangle \\
 &= \begin{pmatrix} e^{-i\frac{\alpha}{2}} & 0 \\ 0 & e^{i\frac{\alpha}{2}} \end{pmatrix} \begin{pmatrix} \cos\frac{\beta}{2} & -\sin\frac{\beta}{2} \\ \sin\frac{\beta}{2} & \cos\frac{\beta}{2} \end{pmatrix} \begin{pmatrix} e^{-i\frac{\gamma}{2}} & 0 \\ 0 & e^{i\frac{\gamma}{2}} \end{pmatrix} \begin{pmatrix} A \\ 0 \end{pmatrix}
 \end{aligned}$$

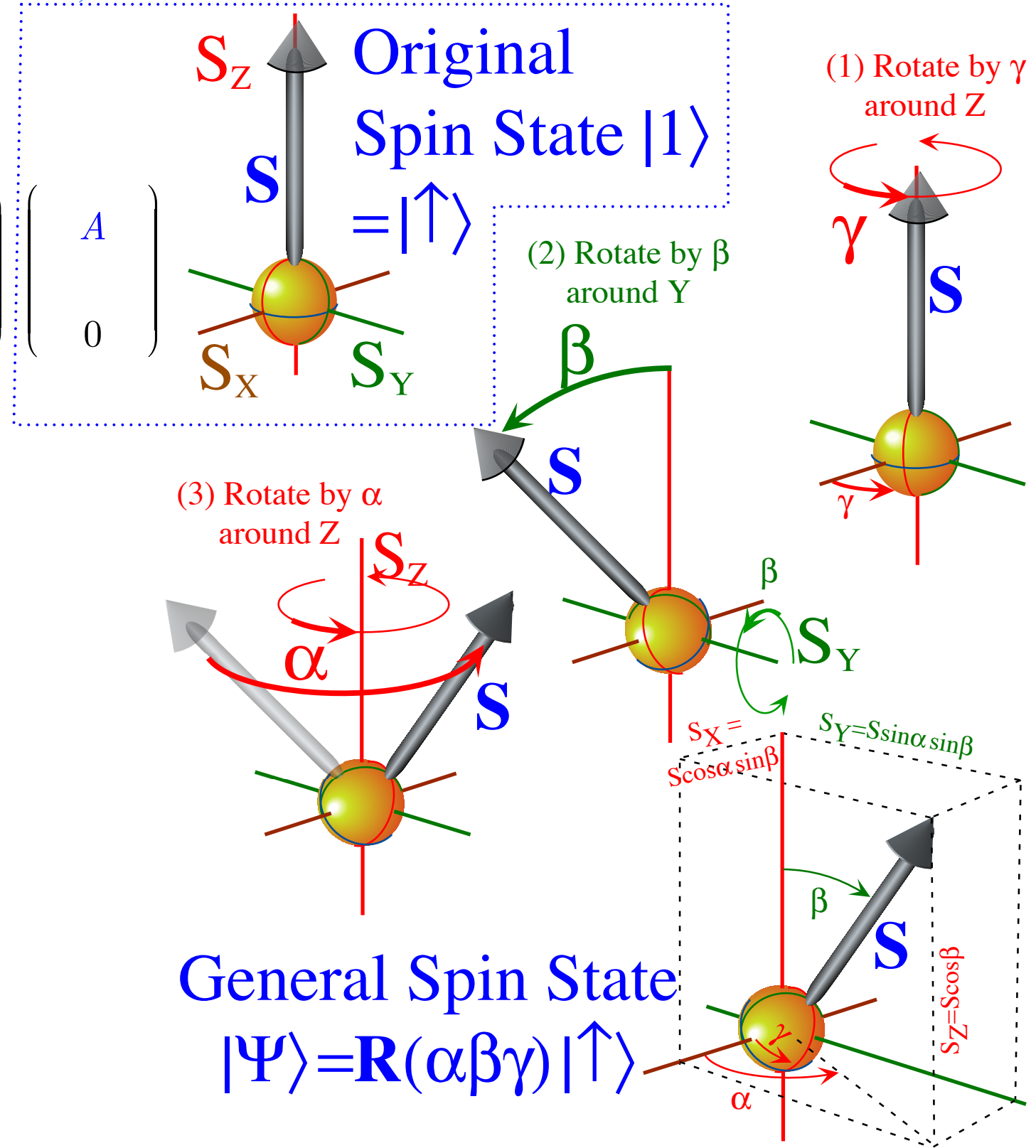

Euler's rotation state definition using rotations $\mathbf{R}(\alpha,0,0)$, $\mathbf{R}(0,\beta,0)$, and $\mathbf{R}(0,0,\gamma)$

Spin-1/2 (2D-complex spinor) case

$$|a\rangle = \mathbf{R}(\alpha\beta\gamma)|\uparrow\rangle$$

$$= \mathbf{R}[\alpha \text{ about } Z] \cdot \mathbf{R}[\beta \text{ about } Y] \cdot \mathbf{R}[\gamma \text{ about } Z]|\uparrow\rangle$$

$$= \begin{pmatrix} e^{-i\frac{\alpha}{2}} & 0 \\ 0 & e^{i\frac{\alpha}{2}} \end{pmatrix} \begin{pmatrix} \cos\frac{\beta}{2} & -\sin\frac{\beta}{2} \\ \sin\frac{\beta}{2} & \cos\frac{\beta}{2} \end{pmatrix} \begin{pmatrix} e^{-i\frac{\gamma}{2}} & 0 \\ 0 & e^{i\frac{\gamma}{2}} \end{pmatrix} \begin{pmatrix} A \\ 0 \end{pmatrix}$$

$$= \begin{pmatrix} e^{-i\frac{\alpha+\gamma}{2}} \cos\frac{\beta}{2} & -e^{-i\frac{\alpha-\gamma}{2}} \sin\frac{\beta}{2} \\ e^{i\frac{\alpha-\gamma}{2}} \sin\frac{\beta}{2} & e^{i\frac{\alpha+\gamma}{2}} \cos\frac{\beta}{2} \end{pmatrix} \begin{pmatrix} A \\ 0 \end{pmatrix}$$

$$= A \begin{pmatrix} e^{-i\frac{\alpha}{2}} \cos\frac{\beta}{2} \\ e^{i\frac{\alpha}{2}} \sin\frac{\beta}{2} \end{pmatrix} e^{-i\frac{\gamma}{2}} = \begin{pmatrix} x_1 + ip_1 \\ x_2 + ip_2 \end{pmatrix}$$

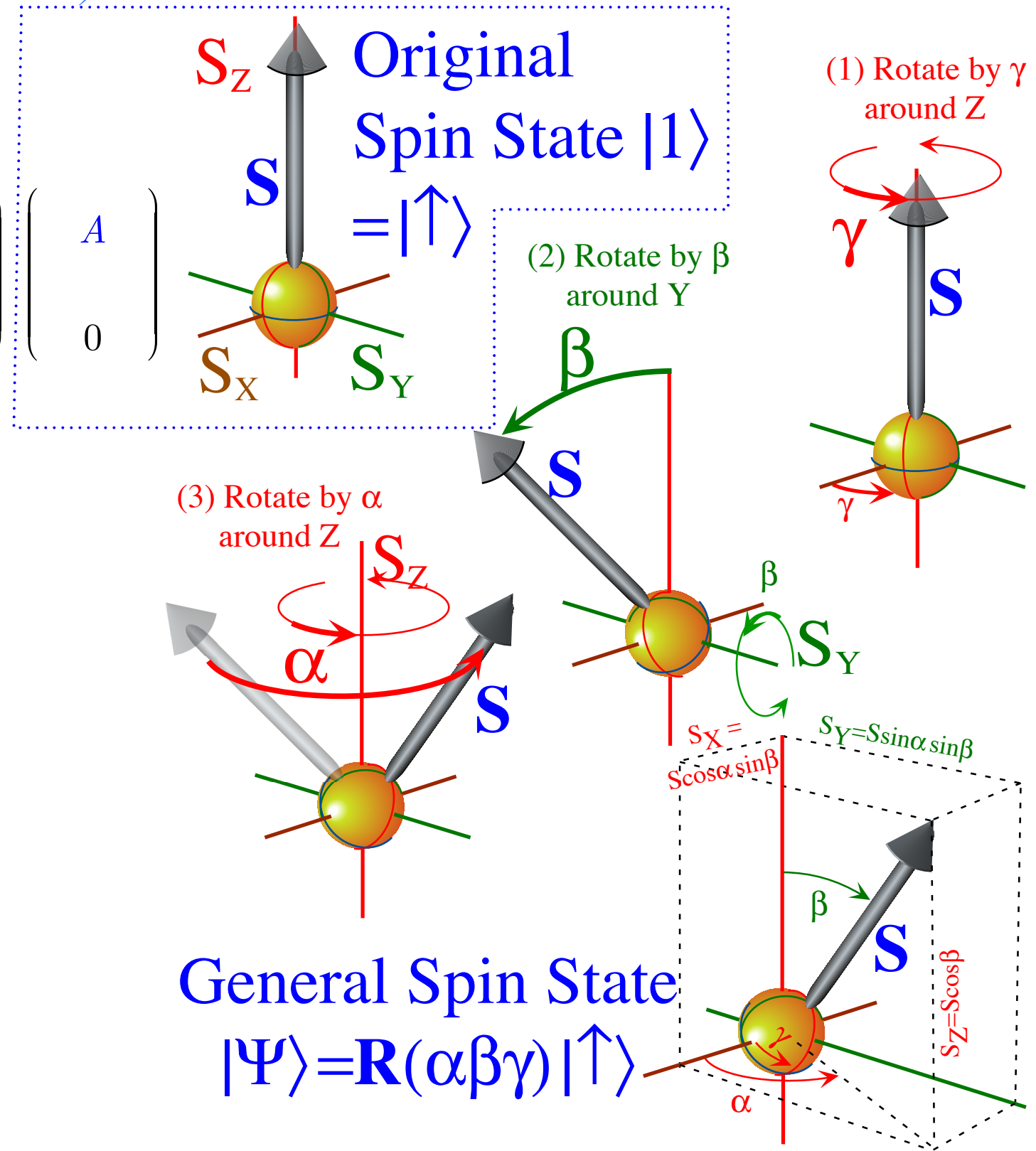

3D-real Stokes Vector defines 2D-HO polarization ellipses and spinor states

➔ *Asymmetry $S_A = S_Z$, Balance $S_B = S_X$, and Chirality $S_C = S_Y$*

Polarization ellipse and spinor state dynamics

The “Great Spectral Avoided-Crossing” and A -to- B -to- A symmetry breaking

3D-real Stokes Vector defines 2D-HO polarization ellipses and spinor states

Asymmetry $S_A = S_Z$, *Balance* $S_B = S_X$, and *Chirality* $S_C = S_Y$

$$\begin{pmatrix} a_1 \\ a_2 \end{pmatrix} = \begin{pmatrix} x_1 + ip_1 \\ x_2 + ip_2 \end{pmatrix}$$

Each point $\{E_1, E_2\}$ defines 2D-HO phase space or analogous Ψ -space given by 2D amplitude array:
This defines real 3D spin vector (S_A, S_B, S_C) “pointing” to a polarization ellipse or state.

$$\text{Asymmetry } S_A = \frac{1}{2}(a|\sigma_A|a) = \frac{1}{2} \begin{pmatrix} a_1^* & a_2^* \end{pmatrix} \begin{pmatrix} 1 & 0 \\ 0 & -1 \end{pmatrix} \begin{pmatrix} a_1 \\ a_2 \end{pmatrix} = \frac{1}{2}[a_1^*a_1 - a_2^*a_2] = \frac{1}{2}[x_1^2 + p_1^2 - x_2^2 - p_2^2]$$

$$\text{Balance } S_B = \frac{1}{2}(a|\sigma_B|a) = \frac{1}{2} \begin{pmatrix} a_1^* & a_2^* \end{pmatrix} \begin{pmatrix} 0 & 1 \\ 1 & 0 \end{pmatrix} \begin{pmatrix} a_1 \\ a_2 \end{pmatrix} = \frac{1}{2}[a_1^*a_2 + a_2^*a_1] = [p_1p_2 + x_1x_2]$$

$$\text{Chirality } S_C = \frac{1}{2}(a|\sigma_C|a) = \frac{1}{2} \begin{pmatrix} a_1^* & a_2^* \end{pmatrix} \begin{pmatrix} 0 & -i \\ i & 0 \end{pmatrix} \begin{pmatrix} a_1 \\ a_2 \end{pmatrix} = \frac{-i}{2}[a_1^*a_2 - a_2^*a_1] = [x_1p_2 - x_2p_1]$$

3D-real Stokes Vector defines 2D-HO polarization ellipses and spinor states

Asymmetry $S_A = S_Z$, **Balance** $S_B = S_X$, and **Chirality** $S_C = S_Y$

Each point $\{E_1, E_2\}$ defines 2D-HO phase space or analogous Ψ -space given by 2D amplitude array: $\begin{pmatrix} a_1 \\ a_2 \end{pmatrix} = \begin{pmatrix} x_1 + ip_1 \\ x_2 + ip_2 \end{pmatrix} = A \begin{pmatrix} e^{-i\frac{\alpha}{2}} \cos \frac{\beta}{2} \\ e^{i\frac{\alpha}{2}} \sin \frac{\beta}{2} \end{pmatrix} e^{-i\frac{\gamma}{2}}$
 This defines real 3D spin vector (S_A, S_B, S_C) "pointing" to a polarization ellipse or state.

$$\begin{aligned}
 \text{Asymmetry } S_A &= \frac{1}{2} \langle a | \sigma_A | a \rangle = \frac{1}{2} \begin{pmatrix} a_1^* & a_2^* \end{pmatrix} \begin{pmatrix} 1 & 0 \\ 0 & -1 \end{pmatrix} \begin{pmatrix} a_1 \\ a_2 \end{pmatrix} = \frac{1}{2} [a_1^* a_1 - a_2^* a_2] = \frac{1}{2} [x_1^2 + p_1^2 - x_2^2 - p_2^2] = \frac{I}{2} [\cos^2 \frac{\beta}{2} - \sin^2 \frac{\beta}{2}] = \frac{I}{2} \cos \beta \\
 \text{Balance } S_B &= \frac{1}{2} \langle a | \sigma_B | a \rangle = \frac{1}{2} \begin{pmatrix} a_1^* & a_2^* \end{pmatrix} \begin{pmatrix} 0 & 1 \\ 1 & 0 \end{pmatrix} \begin{pmatrix} a_1 \\ a_2 \end{pmatrix} = \frac{1}{2} [a_1^* a_2 + a_2^* a_1] = [p_1 p_2 + x_1 x_2] = I \left[-\sin \frac{\alpha+\gamma}{2} \sin \frac{\alpha-\gamma}{2} + \cos \frac{\alpha+\gamma}{2} \cos \frac{\alpha-\gamma}{2} \right] \cos \frac{\beta}{2} \sin \frac{\beta}{2} = \frac{I}{2} \cos \alpha \sin \beta \\
 \text{Chirality } S_C &= \frac{1}{2} \langle a | \sigma_C | a \rangle = \frac{1}{2} \begin{pmatrix} a_1^* & a_2^* \end{pmatrix} \begin{pmatrix} 0 & -i \\ i & 0 \end{pmatrix} \begin{pmatrix} a_1 \\ a_2 \end{pmatrix} = \frac{-i}{2} [a_1^* a_2 - a_2^* a_1] = [x_1 p_2 - x_2 p_1] = I \left[\cos \frac{\alpha+\gamma}{2} \sin \frac{\alpha-\gamma}{2} - \cos \frac{\alpha-\gamma}{2} \sin \frac{\alpha+\gamma}{2} \right] \cos \frac{\beta}{2} \sin \frac{\beta}{2} = \frac{I}{2} \sin \alpha \sin \beta
 \end{aligned}$$

General Spin State
 $|\Psi\rangle = \mathbf{R}(\alpha\beta\gamma) |\uparrow\rangle$

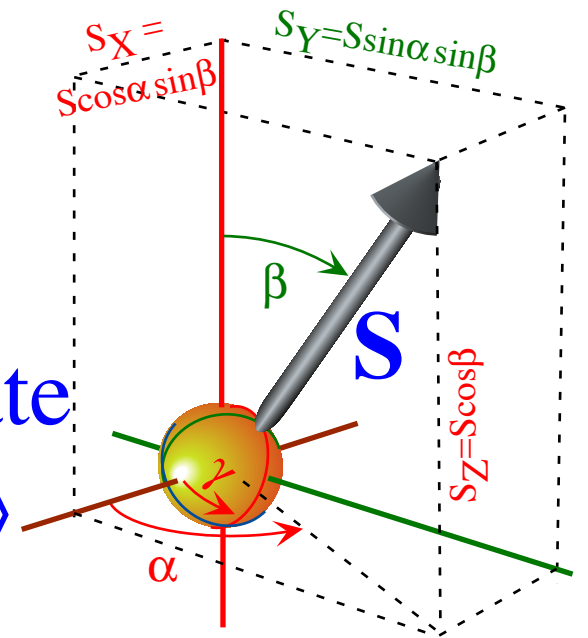

3D-real Stokes Vector defines 2D-HO polarization ellipses and spinor states

Asymmetry $S_A = S_Z$, **Balance** $S_B = S_X$, and **Chirality** $S_C = S_Y$

Each point $\{E_1, E_2\}$ defines 2D-HO phase space or analogous Ψ -space given by 2D amplitude array: $\begin{pmatrix} a_1 \\ a_2 \end{pmatrix} = \begin{pmatrix} x_1 + ip_1 \\ x_2 + ip_2 \end{pmatrix} = A \begin{pmatrix} e^{-i\frac{\alpha}{2}} \cos \frac{\beta}{2} \\ e^{i\frac{\alpha}{2}} \sin \frac{\beta}{2} \end{pmatrix} e^{-i\frac{\gamma}{2}}$
 This defines real 3D spin vector (S_A, S_B, S_C) "pointing" to a polarization ellipse or state.

$$\text{Asymmetry } S_A = \frac{1}{2}(a|\sigma_A|a) = \frac{1}{2} \begin{pmatrix} a_1^* & a_2^* \end{pmatrix} \begin{pmatrix} 1 & 0 \\ 0 & -1 \end{pmatrix} \begin{pmatrix} a_1 \\ a_2 \end{pmatrix} = \frac{1}{2}[a_1^*a_1 - a_2^*a_2] = \frac{1}{2}[x_1^2 + p_1^2 - x_2^2 - p_2^2] = \frac{I}{2}[\cos^2 \frac{\beta}{2} - \sin^2 \frac{\beta}{2}] = \frac{I}{2} \cos \beta$$

$$\text{Balance } S_B = \frac{1}{2}(a|\sigma_B|a) = \frac{1}{2} \begin{pmatrix} a_1^* & a_2^* \end{pmatrix} \begin{pmatrix} 0 & 1 \\ 1 & 0 \end{pmatrix} \begin{pmatrix} a_1 \\ a_2 \end{pmatrix} = \frac{1}{2}[a_1^*a_2 + a_2^*a_1] = [p_1 p_2 + x_1 x_2] = I \left[-\sin \frac{\alpha+\gamma}{2} \sin \frac{\alpha-\gamma}{2} + \cos \frac{\alpha+\gamma}{2} \cos \frac{\alpha-\gamma}{2} \right] \cos \frac{\beta}{2} \sin \frac{\beta}{2} = \frac{I}{2} \cos \alpha \sin \beta$$

$$\text{Chirality } S_C = \frac{1}{2}(a|\sigma_C|a) = \frac{1}{2} \begin{pmatrix} a_1^* & a_2^* \end{pmatrix} \begin{pmatrix} 0 & -i \\ i & 0 \end{pmatrix} \begin{pmatrix} a_1 \\ a_2 \end{pmatrix} = \frac{-i}{2}[a_1^*a_2 - a_2^*a_1] = [x_1 p_2 - x_2 p_1] = I \left[\cos \frac{\alpha+\gamma}{2} \sin \frac{\alpha-\gamma}{2} - \cos \frac{\alpha-\gamma}{2} \sin \frac{\alpha+\gamma}{2} \right] \cos \frac{\beta}{2} \sin \frac{\beta}{2} = \frac{I}{2} \sin \alpha \sin \beta$$

General Spin State
 $|\Psi\rangle = \mathbf{R}(\alpha\beta\gamma) |\uparrow\rangle$

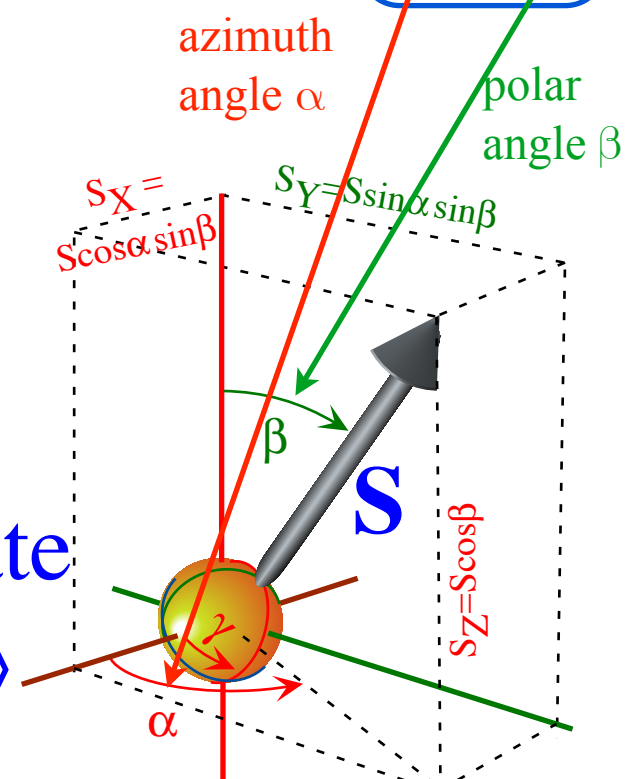

Note phase or "gauge" angle γ is killed in $R(3)$ a^*a -squares but lives on in $U(2)$.

3D-real Stokes Vector defines 2D-HO polarization ellipses and spinor states

Asymmetry $S_A = S_Z$, Balance $S_B = S_X$, and Chirality $S_C = S_Y$

Each point $\{E_1, E_2\}$ defines 2D-HO phase space or analogous Ψ -space given by 2D amplitude array: $\begin{pmatrix} a_1 \\ a_2 \end{pmatrix} = \begin{pmatrix} x_1 + ip_1 \\ x_2 + ip_2 \end{pmatrix} = A \begin{pmatrix} e^{-i\frac{\alpha}{2}} \cos \frac{\beta}{2} \\ e^{i\frac{\alpha}{2}} \sin \frac{\beta}{2} \end{pmatrix} e^{-i\frac{\gamma}{2}}$
 This defines real 3D spin vector (S_A, S_B, S_C) "pointing" to a polarization ellipse or state.

$$\text{Asymmetry } S_A = \frac{1}{2}(a|\sigma_A|a) = \frac{1}{2} \begin{pmatrix} a_1^* & a_2^* \end{pmatrix} \begin{pmatrix} 1 & 0 \\ 0 & -1 \end{pmatrix} \begin{pmatrix} a_1 \\ a_2 \end{pmatrix} = \frac{1}{2}[a_1^*a_1 - a_2^*a_2] = \frac{1}{2}[x_1^2 + p_1^2 - x_2^2 - p_2^2] = \frac{I}{2}[\cos^2 \frac{\beta}{2} - \sin^2 \frac{\beta}{2}] = \frac{I}{2} \cos \beta$$

$$\text{Balance } S_B = \frac{1}{2}(a|\sigma_B|a) = \frac{1}{2} \begin{pmatrix} a_1^* & a_2^* \end{pmatrix} \begin{pmatrix} 0 & 1 \\ 1 & 0 \end{pmatrix} \begin{pmatrix} a_1 \\ a_2 \end{pmatrix} = \frac{1}{2}[a_1^*a_2 + a_2^*a_1] = [p_1 p_2 + x_1 x_2] = I \left[-\sin \frac{\alpha+\gamma}{2} \sin \frac{\alpha-\gamma}{2} + \cos \frac{\alpha+\gamma}{2} \cos \frac{\alpha-\gamma}{2} \right] \cos \frac{\beta}{2} \sin \frac{\beta}{2} = \frac{I}{2} \cos \alpha \sin \beta$$

$$\text{Chirality } S_C = \frac{1}{2}(a|\sigma_C|a) = \frac{1}{2} \begin{pmatrix} a_1^* & a_2^* \end{pmatrix} \begin{pmatrix} 0 & -i \\ i & 0 \end{pmatrix} \begin{pmatrix} a_1 \\ a_2 \end{pmatrix} = \frac{-i}{2}[a_1^*a_2 - a_2^*a_1] = [x_1 p_2 - x_2 p_1] = I \left[\cos \frac{\alpha+\gamma}{2} \sin \frac{\alpha-\gamma}{2} - \cos \frac{\alpha-\gamma}{2} \sin \frac{\alpha+\gamma}{2} \right] \cos \frac{\beta}{2} \sin \frac{\beta}{2} = \frac{I}{2} \sin \alpha \sin \beta$$

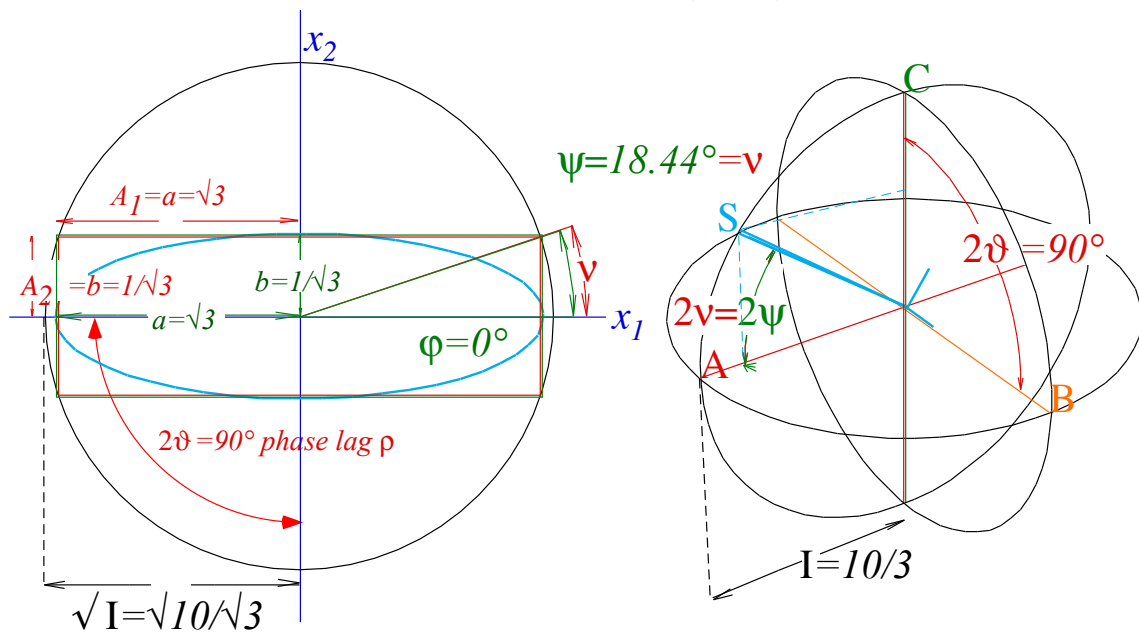

General Spin State $|\Psi\rangle = \mathbf{R}(\alpha\beta\gamma) |\uparrow\rangle$

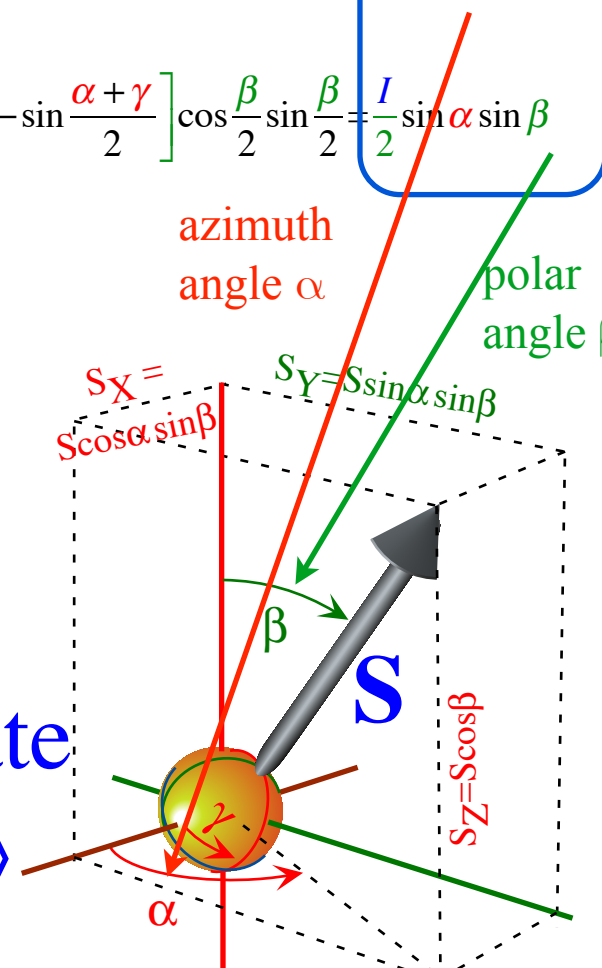

Note phase or "gauge" angle γ is killed in $R(3)$ a^*a -squares but lives on in $U(2)$.

3D-real Stokes Vector defines 2D-HO polarization ellipses and spinor states

Asymmetry $S_A = S_Z$, Balance $S_B = S_X$, and Chirality $S_C = S_Y$

Each point $\{E_1, E_2\}$ defines 2D-HO phase space or analogous Ψ -space given by 2D amplitude array: $\begin{pmatrix} a_1 \\ a_2 \end{pmatrix} = \begin{pmatrix} x_1 + ip_1 \\ x_2 + ip_2 \end{pmatrix} = A \begin{pmatrix} e^{-i\frac{\alpha}{2}} \cos \frac{\beta}{2} \\ e^{i\frac{\alpha}{2}} \sin \frac{\beta}{2} \end{pmatrix} e^{-i\frac{\gamma}{2}}$
 This defines real 3D spin vector (S_A, S_B, S_C) "pointing" to a polarization ellipse or state.

$$\text{Asymmetry } S_A = \frac{1}{2}(a|\sigma_A|a) = \frac{1}{2} \begin{pmatrix} a_1^* & a_2^* \end{pmatrix} \begin{pmatrix} 1 & 0 \\ 0 & -1 \end{pmatrix} \begin{pmatrix} a_1 \\ a_2 \end{pmatrix} = \frac{1}{2}[a_1^* a_1 - a_2^* a_2] = \frac{1}{2}[x_1^2 + p_1^2 - x_2^2 - p_2^2] = \frac{I}{2}[\cos^2 \frac{\beta}{2} - \sin^2 \frac{\beta}{2}] = \frac{I}{2} \cos \beta$$

$$\text{Balance } S_B = \frac{1}{2}(a|\sigma_B|a) = \frac{1}{2} \begin{pmatrix} a_1^* & a_2^* \end{pmatrix} \begin{pmatrix} 0 & 1 \\ 1 & 0 \end{pmatrix} \begin{pmatrix} a_1 \\ a_2 \end{pmatrix} = \frac{1}{2}[a_1^* a_2 + a_2^* a_1] = [p_1 p_2 + x_1 x_2] = I \left[-\sin \frac{\alpha+\gamma}{2} \sin \frac{\alpha-\gamma}{2} + \cos \frac{\alpha+\gamma}{2} \cos \frac{\alpha-\gamma}{2} \right] \cos \frac{\beta}{2} \sin \frac{\beta}{2} = \frac{I}{2} \cos \alpha \sin \beta$$

$$\text{Chirality } S_C = \frac{1}{2}(a|\sigma_C|a) = \frac{1}{2} \begin{pmatrix} a_1^* & a_2^* \end{pmatrix} \begin{pmatrix} 0 & -i \\ i & 0 \end{pmatrix} \begin{pmatrix} a_1 \\ a_2 \end{pmatrix} = \frac{-i}{2}[a_1^* a_2 - a_2^* a_1] = [x_1 p_2 - x_2 p_1] = I \left[\cos \frac{\alpha+\gamma}{2} \sin \frac{\alpha-\gamma}{2} - \cos \frac{\alpha-\gamma}{2} \sin \frac{\alpha+\gamma}{2} \right] \cos \frac{\beta}{2} \sin \frac{\beta}{2} = \frac{I}{2} \sin \alpha \sin \beta$$

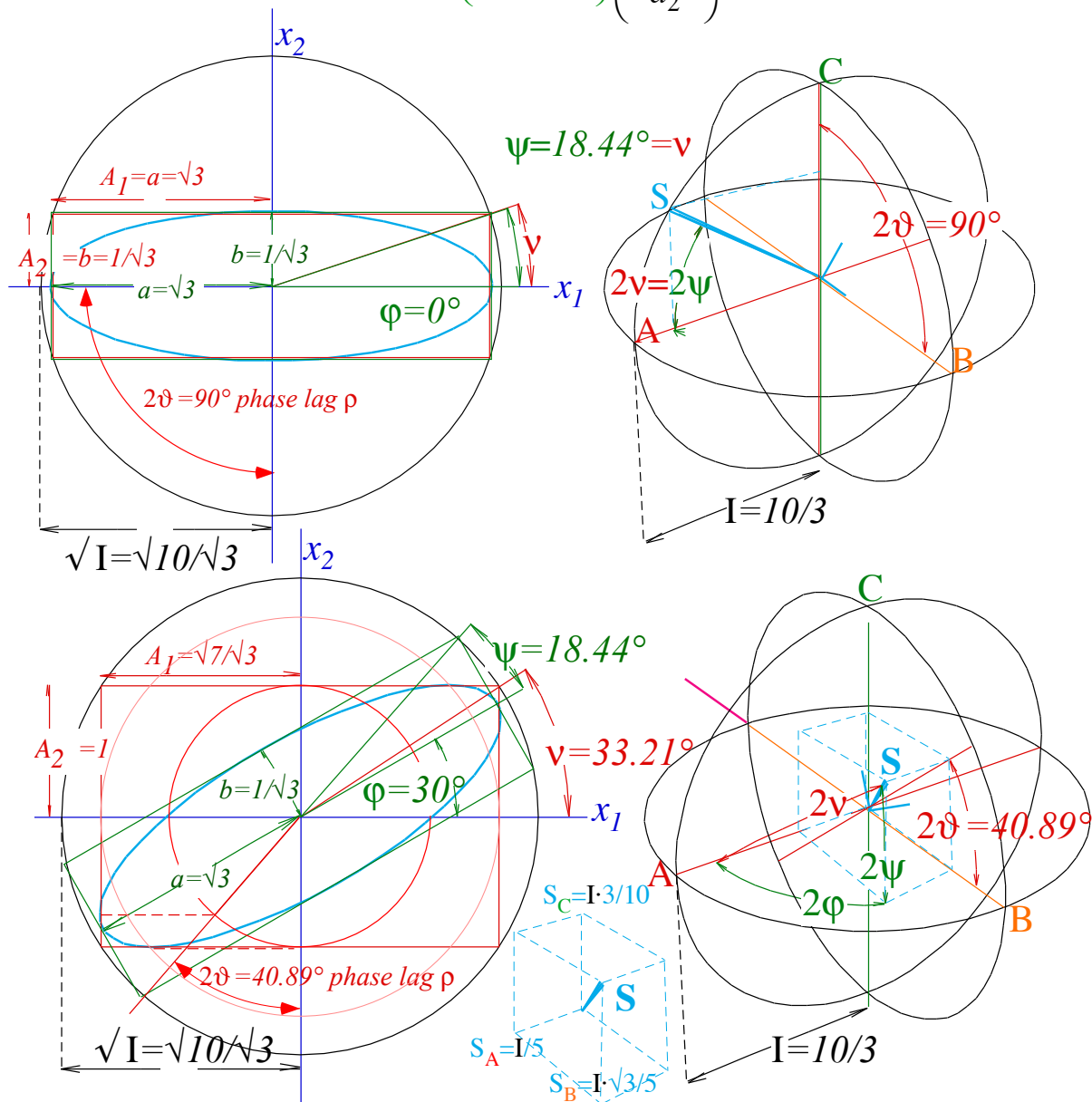

General Spin State
 $|\Psi\rangle = \mathbf{R}(\alpha\beta\gamma) |\uparrow\rangle$

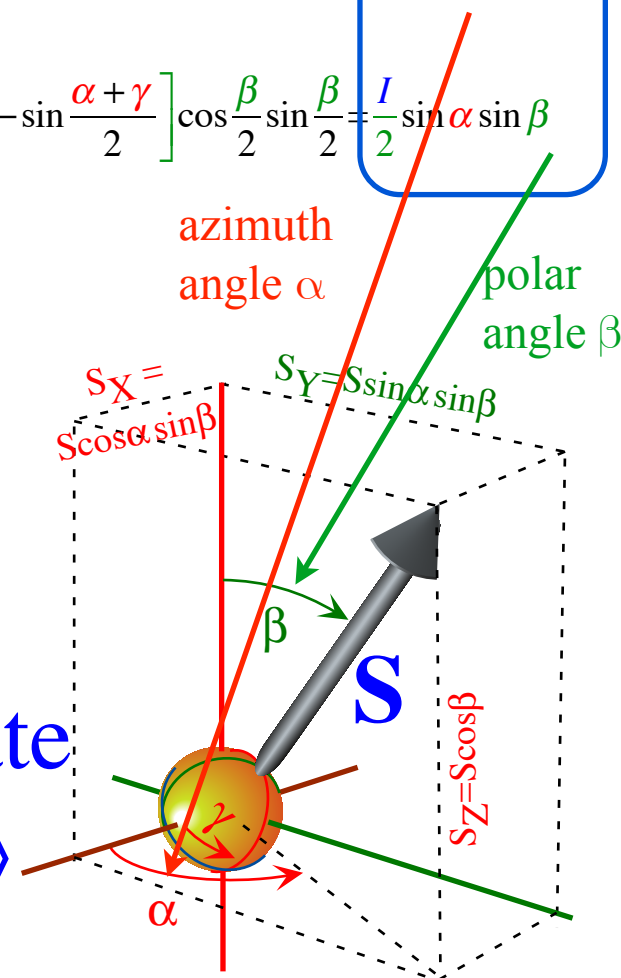

Note phase or "gauge" angle γ is killed in $R(3)$ a^*a -squares but lives on in $U(2)$.

Polarization ellipse and spinor state dynamics

Note phase or “gauge” angle γ is killed in $R(3)$ $a \cdot a$ -squares but lives on in $U(2)$.

(a)
Stokes Vector
ABC-Space
 $R(3)$

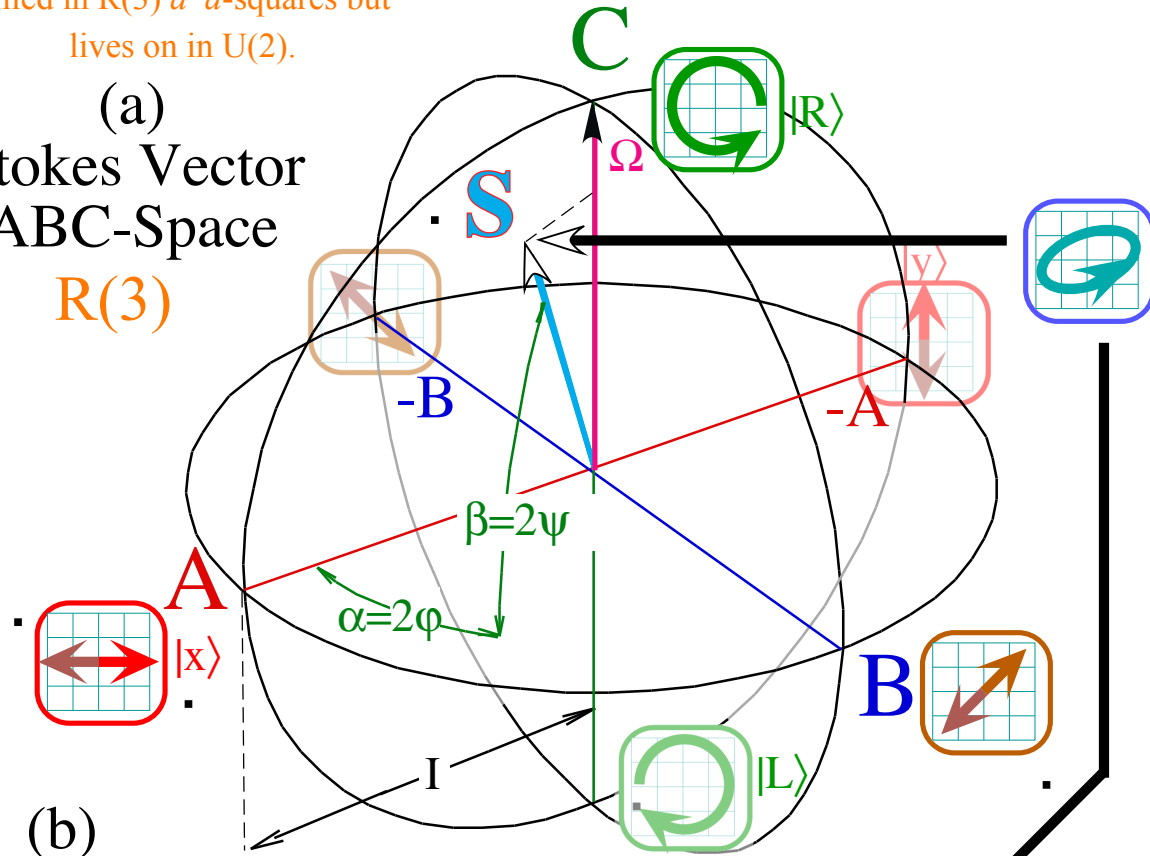

(b)
Polarization
xy-Space
 $U(2)$

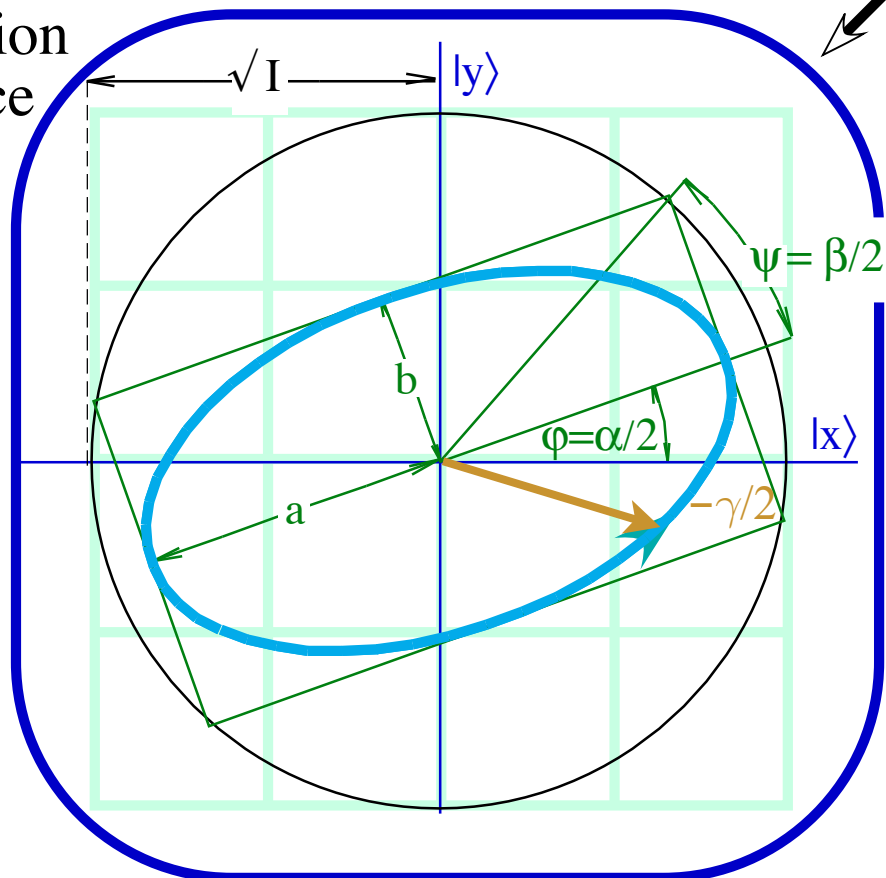

From:
QTCA
Lect. 9(2.12)
p. 69

Fig. 3.4.5 Polarization variables (a) Stokes real-vector space (ABC) (b) Complex xy-spinor-space (x_1, x_2) .

3D-real Stokes Vector defines 2D-HO polarization ellipses and spinor states

Asymmetry $S_A = S_Z$, Balance $S_B = S_X$, and Chirality $S_C = S_Y$

➔ *Polarization ellipse and spinor state dynamics*

The “Great Spectral Avoided-Crossing” and A -to- B -to- A symmetry breaking

3D-real Stokes Vector defines 2D-HO polarization ellipses and spinor states

Asymmetry $S_A = S_Z$ Balance $S_B = S_X$, and Chirality $S_C = S_Y$

Polarization ellipse and spinor state dynamics

➔ *The “Great Spectral Avoided-Crossing” and A -to- B -to- A symmetry breaking*

Polarization ellipse and spinor state dynamics (A-Type motion)

Note phase or "gauge" angle γ is killed in $R(3)$ a^*a -squares but lives on in $U(2)$.

(a) Stokes Vector ABC-Space $R(3)$

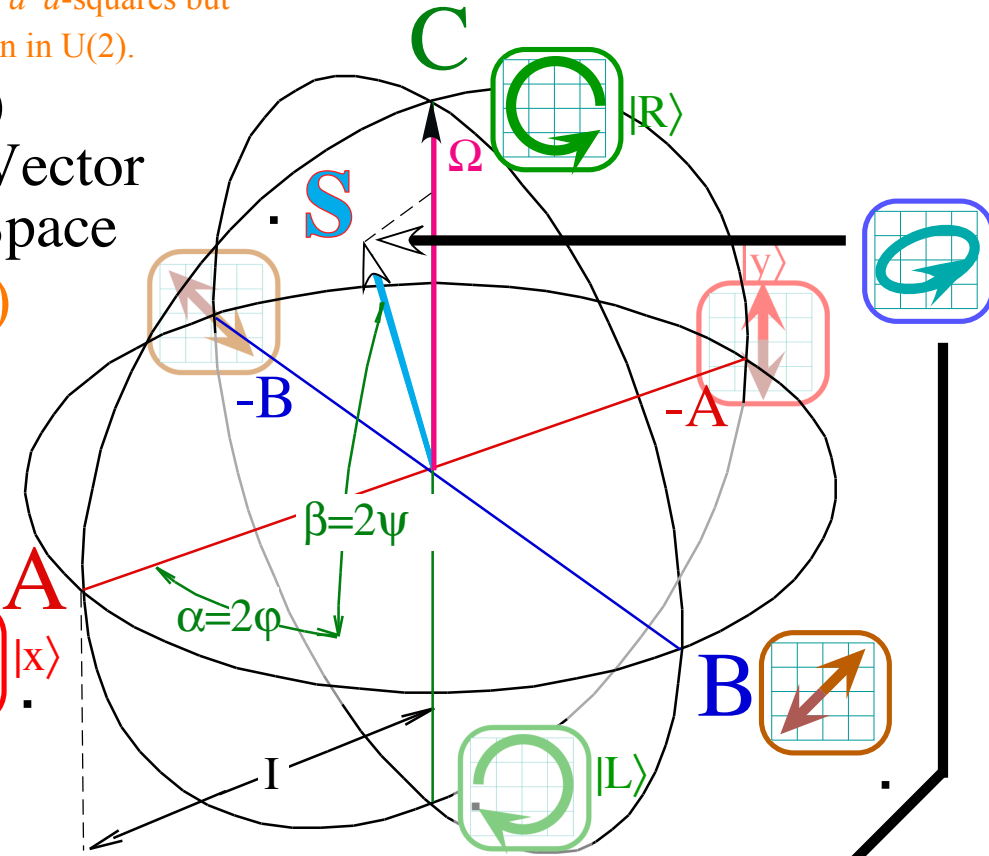

(b) Polarization xy-Space $U(2)$

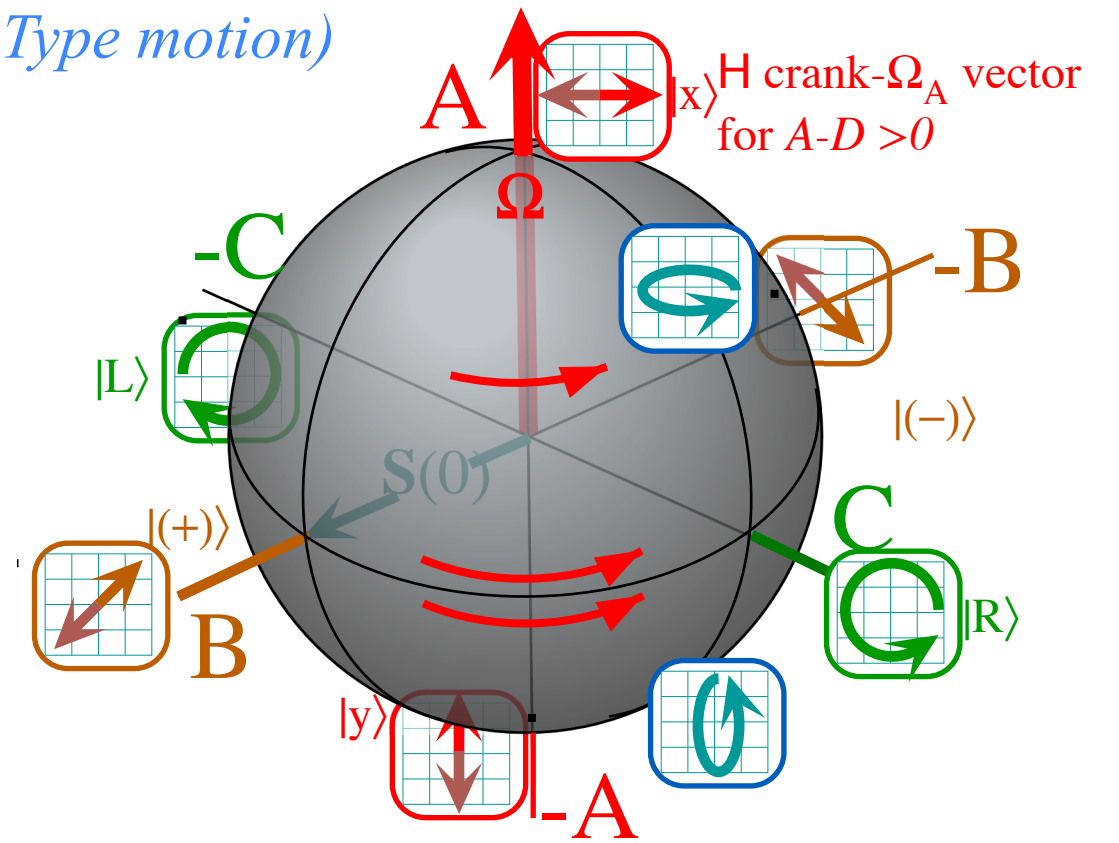
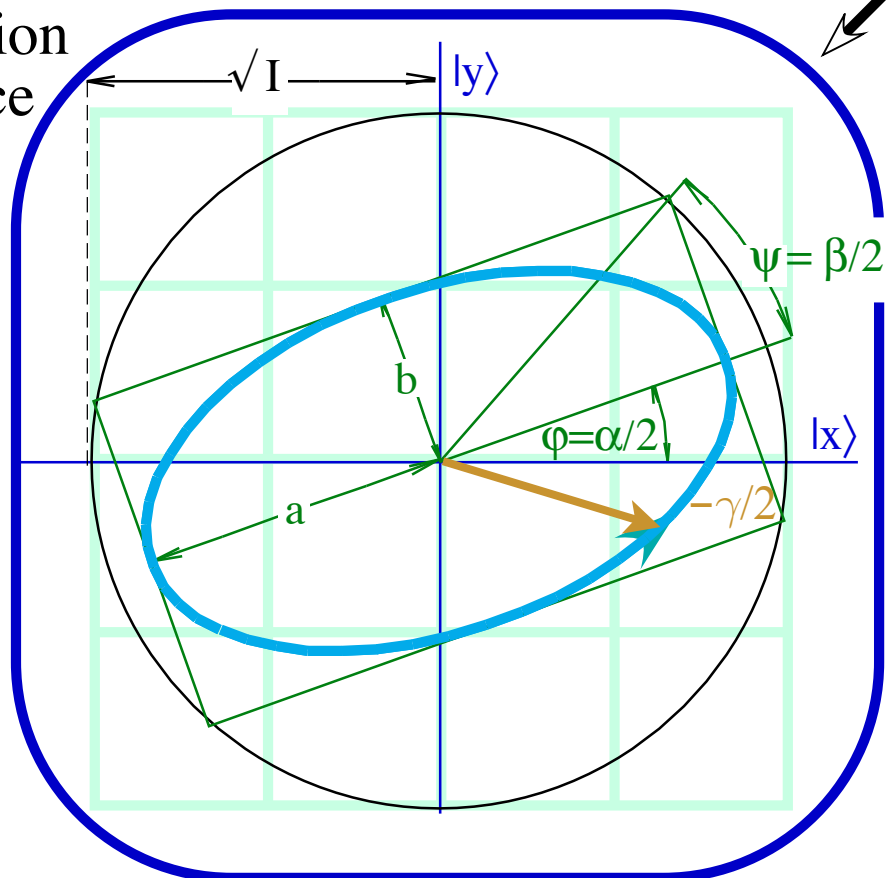

Fig. 3.4.5 Polarization variables (a) Stokes real-vector space (ABC) (b) Complex xy-spinor-space (x_1, x_2) .

3D-real Stokes Vector defines 2D-HO polarization ellipses and spinor states

Asymmetry $S_A = S_Z$, Balance $S_B = S_X$ and Chirality $S_C = S_Y$

Polarization ellipse and spinor state dynamics

➔ *The “Great Spectral Avoided-Crossing” and A -to- B -to- A symmetry breaking*

Polarization ellipse and spinor state dynamics (B-Type motion)

Note phase or "gauge" angle γ is killed in $R(3)$ $a \cdot a$ -squares but lives on in $U(2)$.

(a) Stokes Vector ABC-Space $R(3)$

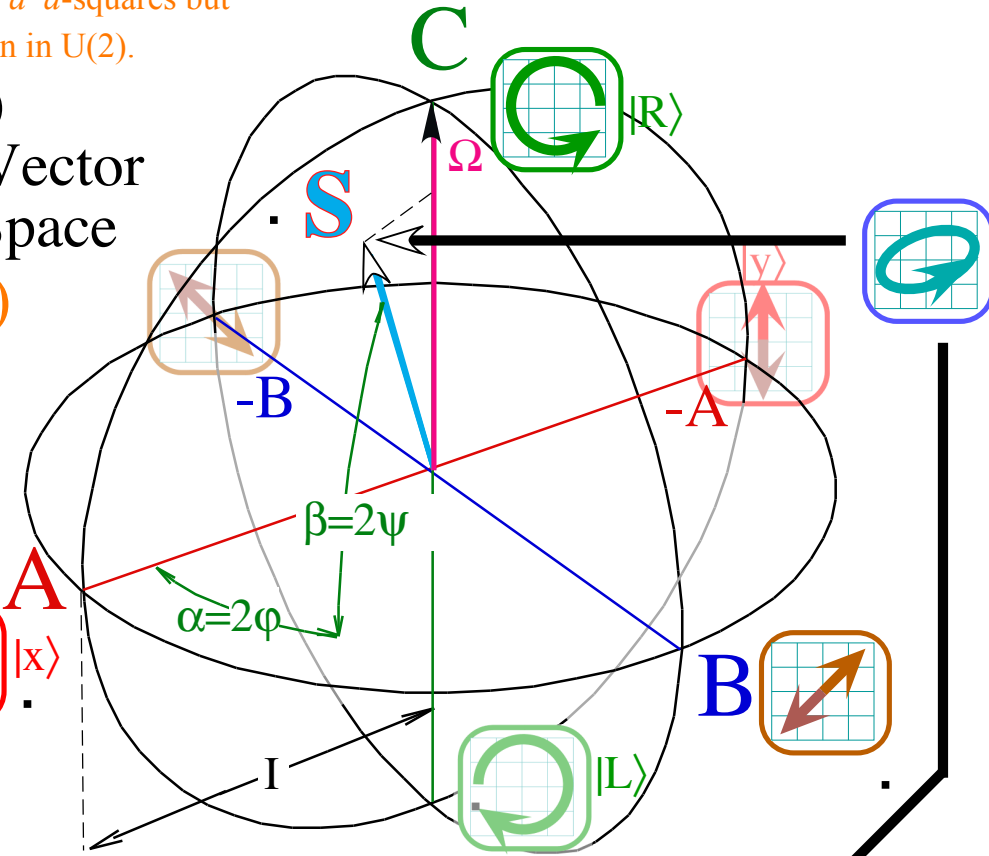

(b) Polarization xy-Space $U(2)$

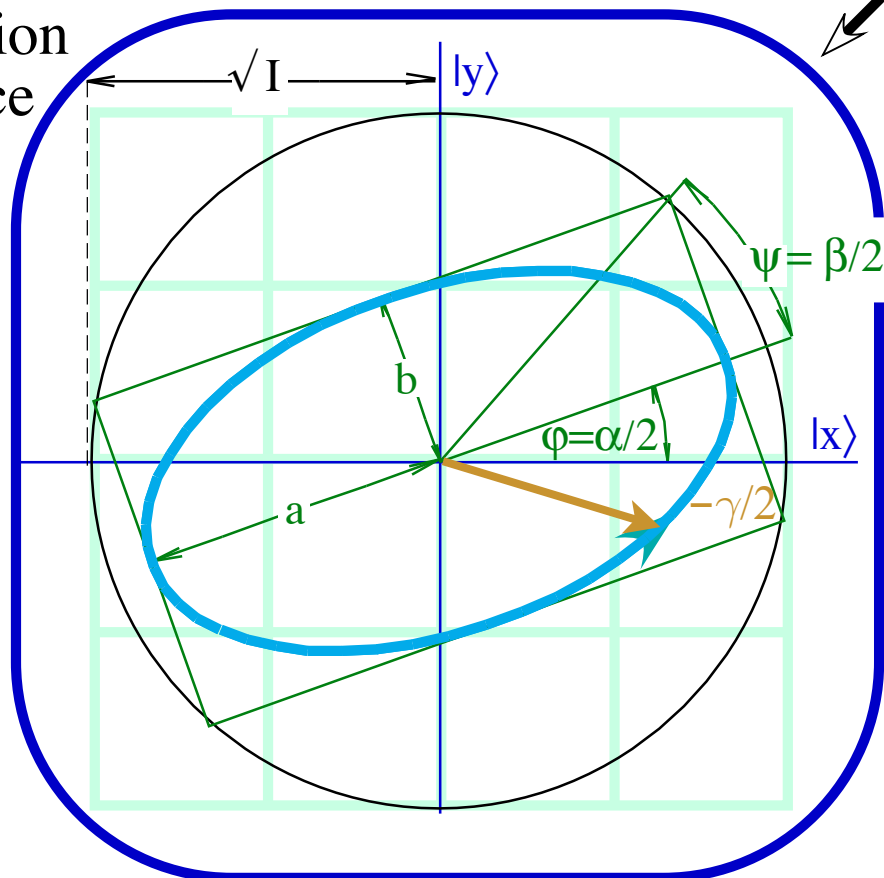

Fig. 3.4.5 Polarization variables (a) Stokes real-vector space (ABC) (b) Complex xy-spinor-space (x_1, x_2) .

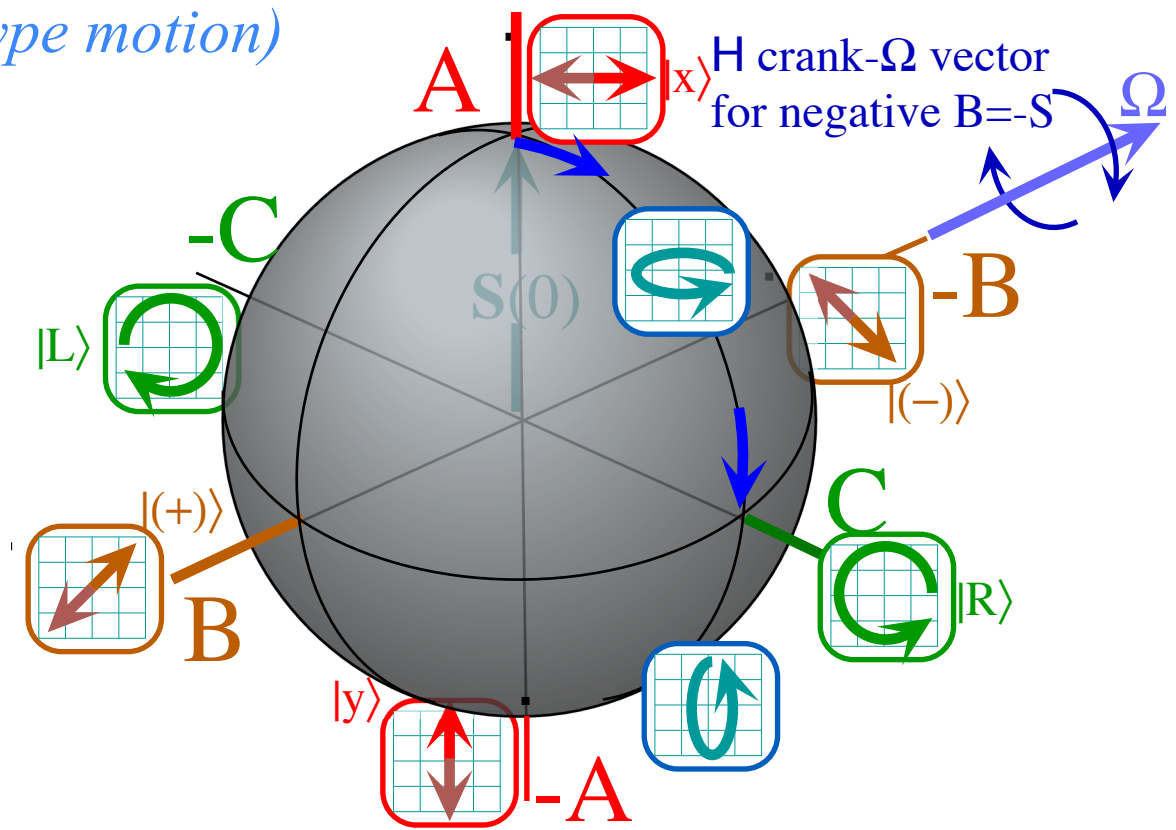

Fig. 3.4.6 Time evolution of a B-type beat. S-vector rotates from A to C to -A to -C and back to A.

The ABC's of $U(2)$ dynamics (B-Type motion)

$$\begin{pmatrix} \langle 1|\mathbf{H}|1\rangle & \langle 1|\mathbf{H}|2\rangle \\ \langle 2|\mathbf{H}|1\rangle & \langle 2|\mathbf{H}|2\rangle \end{pmatrix} = \begin{pmatrix} A & B-iC \\ B+iC & D \end{pmatrix} = \frac{A+D}{2} \begin{pmatrix} 1 & 0 \\ 0 & 1 \end{pmatrix} + B \begin{pmatrix} 0 & 1 \\ 1 & 0 \end{pmatrix} + C \begin{pmatrix} 0 & -i \\ i & 0 \end{pmatrix} + \frac{A-D}{2} \begin{pmatrix} 1 & 0 \\ 0 & -1 \end{pmatrix}$$

From:
QTCA
Lect. 9(2.12)
p. 54

$$= \frac{A+D}{2} \mathbf{1} + B \sigma_B + C \sigma_C + \frac{A-D}{2} \sigma_A$$

$$= \frac{A+D}{2} \sigma_0 + \frac{\Omega_B}{2} \sigma_B + \frac{\Omega_C}{2} \sigma_C + \frac{\Omega_A}{2} \sigma_A$$

$$\rho = \frac{1}{2} N \mathbf{1} + \vec{S} \cdot \boldsymbol{\sigma}$$

$$\mathbf{H} = \Omega_0 \mathbf{1} + \frac{\vec{\Omega}}{2} \cdot \boldsymbol{\sigma}$$

$$\vec{\Omega} = \begin{pmatrix} \Omega_A \\ \Omega_B \\ \Omega_C \end{pmatrix} = \begin{pmatrix} A-D \\ 2B \\ 2C \end{pmatrix}$$

Bilateral-Balanced B-Type motion

$$\begin{pmatrix} \langle 1|\mathbf{H}^B|1\rangle & \langle 1|\mathbf{H}^B|2\rangle \\ \langle 2|\mathbf{H}^B|1\rangle & \langle 2|\mathbf{H}^B|2\rangle \end{pmatrix} = \begin{pmatrix} \Omega_0 & B \\ B & \Omega_0 \end{pmatrix} = \Omega_0 \begin{pmatrix} 1 & 0 \\ 0 & 1 \end{pmatrix} + B \begin{pmatrix} 0 & 1 \\ 1 & 0 \end{pmatrix} = \Omega_0 \sigma_0 + \frac{\Omega_B}{2} \sigma_B$$

Crank: $\vec{\Omega} = \begin{pmatrix} \Omega_A \\ \Omega_B \\ \Omega_C \end{pmatrix} = \begin{pmatrix} 0 \\ 2B \\ 0 \end{pmatrix}$

Eigen-Spin: $\vec{S} = \begin{pmatrix} S_A \\ S_B \\ S_C \end{pmatrix} = \begin{pmatrix} 0 \\ \pm S \\ 0 \end{pmatrix}$

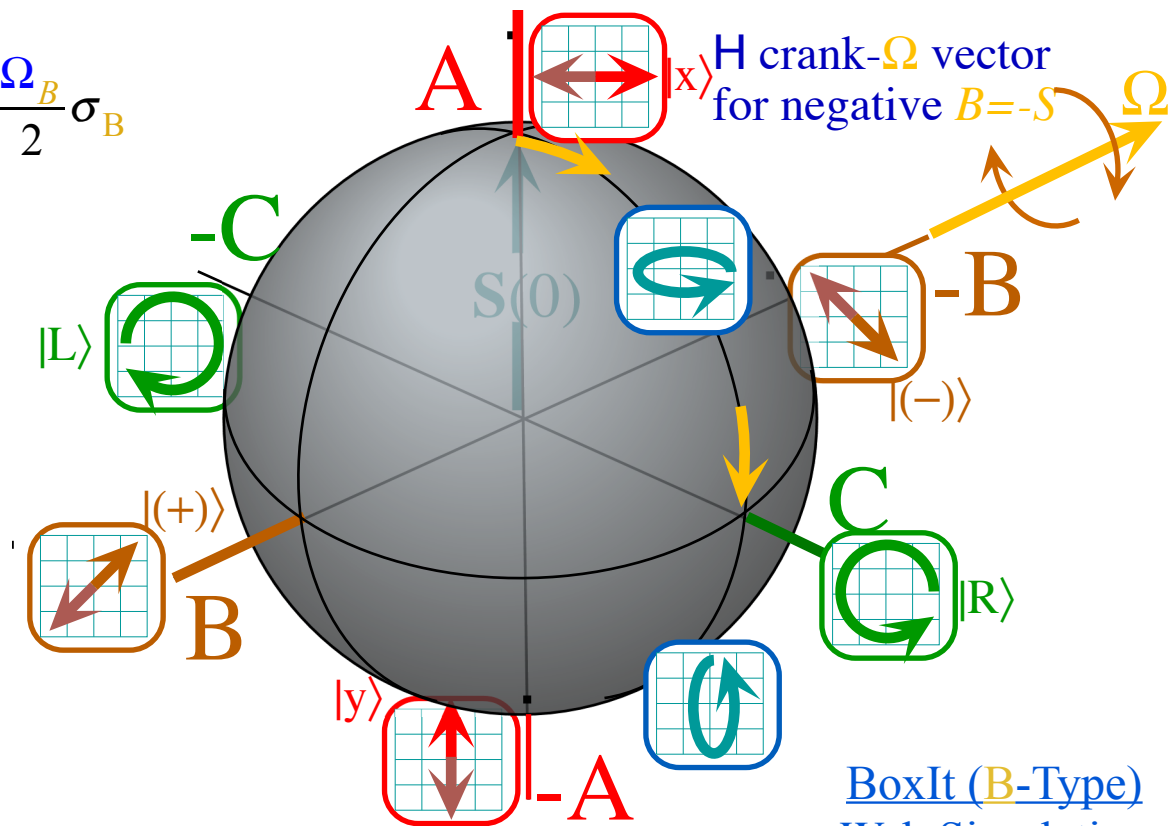

Beat dynamics:

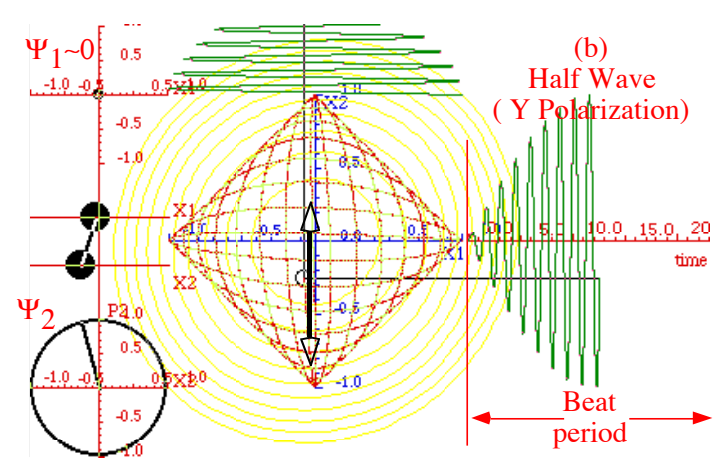
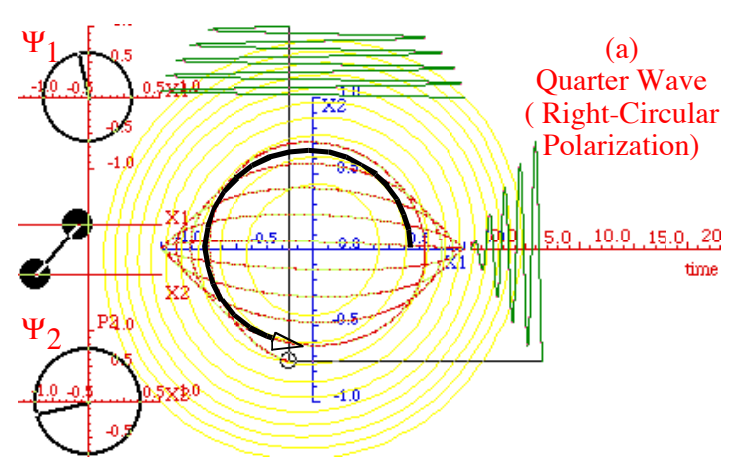
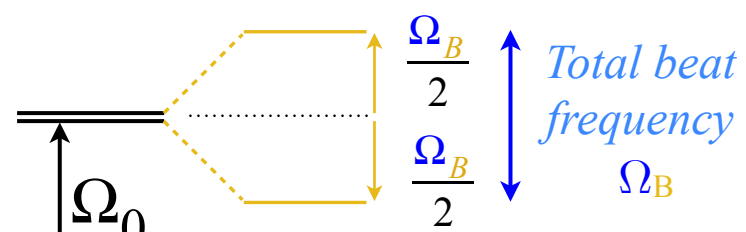
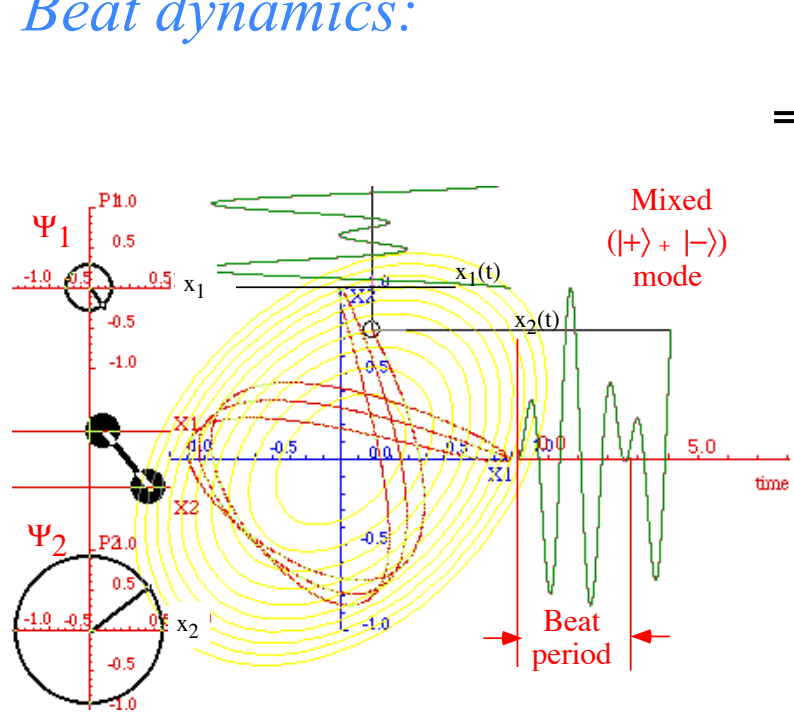

3D-real Stokes Vector defines 2D-HO polarization ellipses and spinor states

Asymmetry $S_A = S_Z$, Balance $S_B = S_X$, and Chirality $S_C = S_Y$

Polarization ellipse and spinor state dynamics

➔ *The “Great Spectral Avoided-Crossing” and A -to- B -to- A symmetry breaking*

Polarization ellipse and spinor state dynamics (C-Type motion)

Note phase or "gauge" angle γ is killed in $R(3)$ a^*a -squares but lives on in $U(2)$.

C (Chiral-circular-complex-Coriolis-cyclotron-curly...current-carrier...)

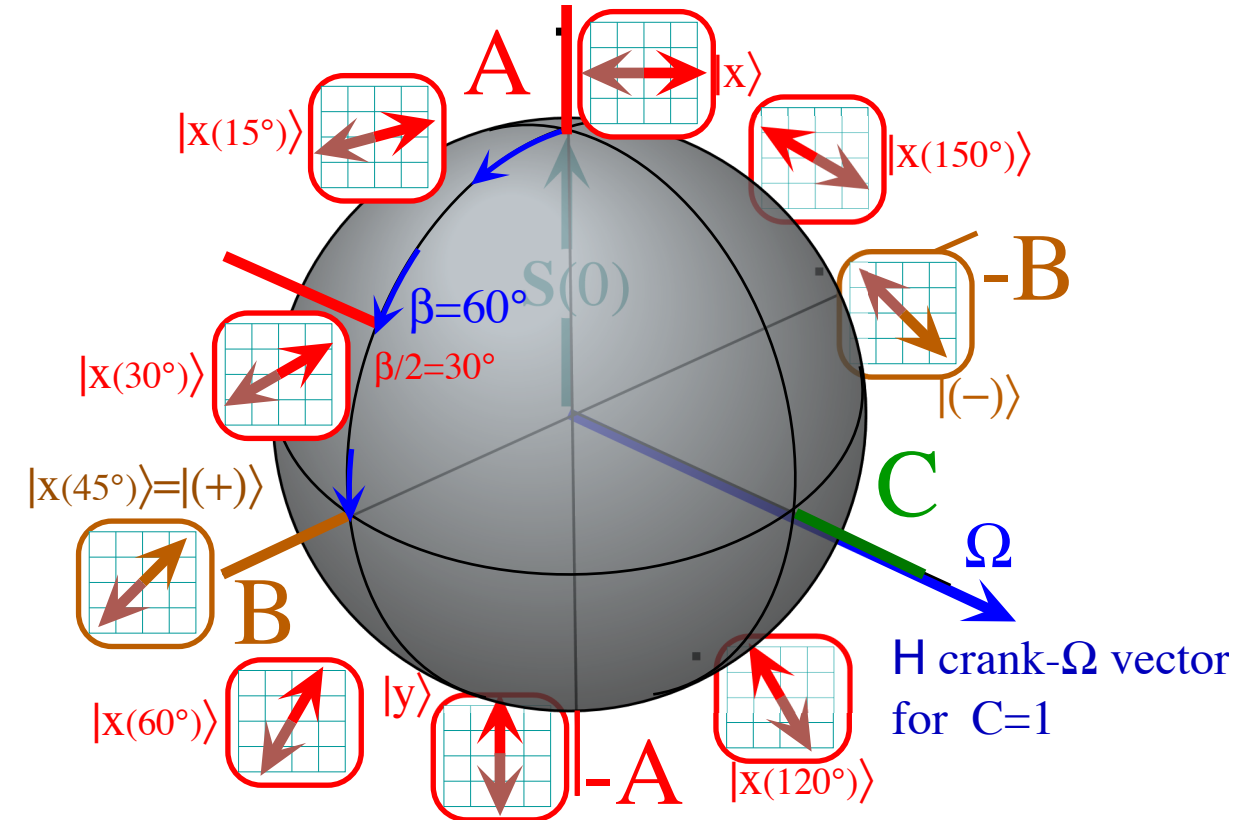
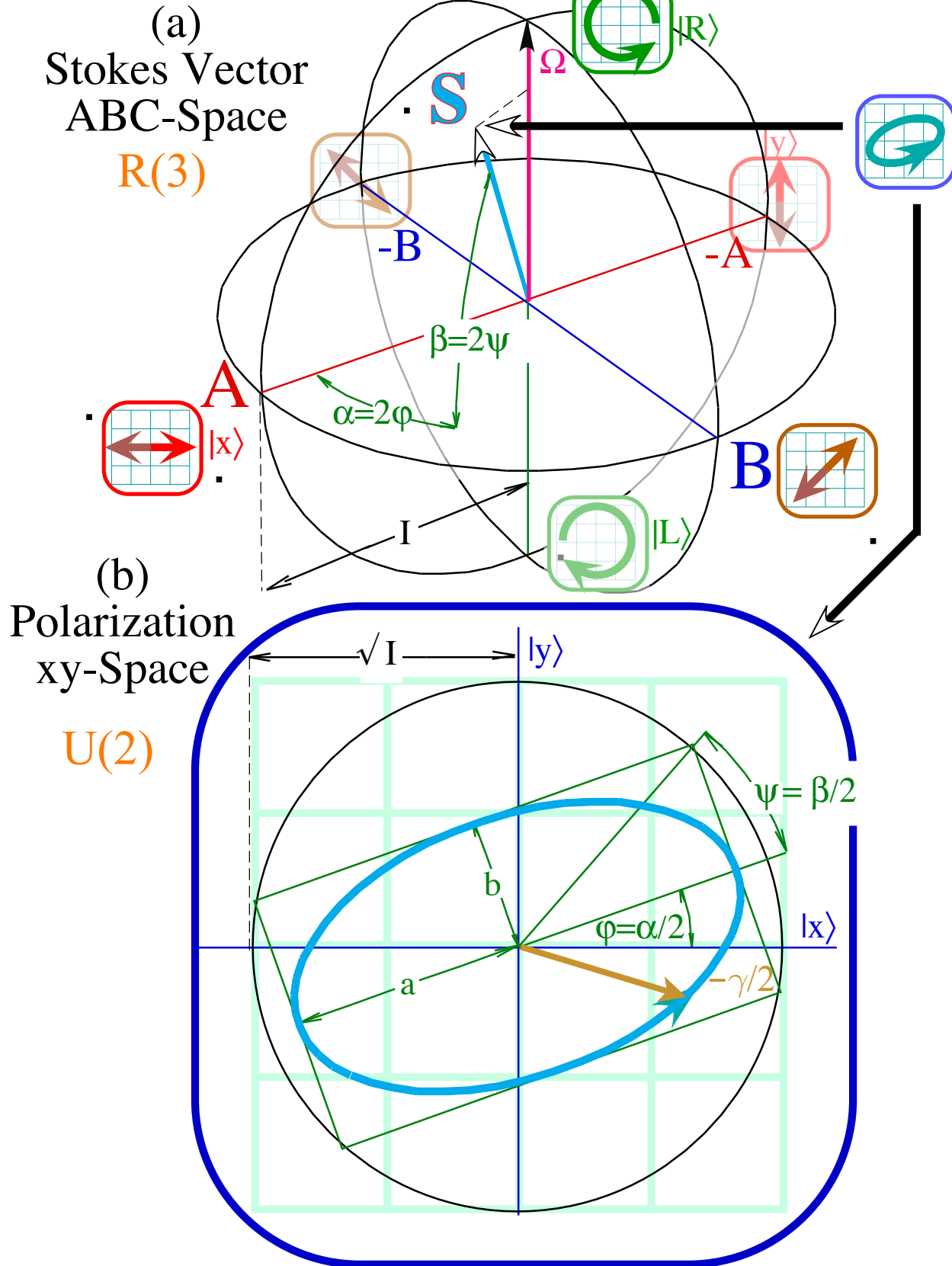

Fig. 3.4.7 Time evolution of a C-type beat. S -vector rotates from A to B to $-A$ to $-B$ and back to A .

Fig. 3.4.5 Polarization variables (a) Stokes real-vector space (ABC) (b) Complex xy-spinor-space (x_1, x_2) .

The ABC's of $U(2)$ dynamics (C-Type motion)

$$\rho = \frac{1}{2} N \mathbf{1} + \vec{S} \cdot \vec{\sigma}$$

$$\mathbf{H} = \Omega_0 \mathbf{1} + \frac{\vec{\Omega}}{2} \cdot \vec{\sigma}$$

$$\begin{pmatrix} \langle 1|\mathbf{H}|1\rangle & \langle 1|\mathbf{H}|2\rangle \\ \langle 2|\mathbf{H}|1\rangle & \langle 2|\mathbf{H}|2\rangle \end{pmatrix} = \begin{pmatrix} A & B-iC \\ B+iC & D \end{pmatrix} = \frac{A+D}{2} \begin{pmatrix} 1 & 0 \\ 0 & 1 \end{pmatrix} + B \begin{pmatrix} 0 & 1 \\ 1 & 0 \end{pmatrix} + C \begin{pmatrix} 0 & -i \\ i & 0 \end{pmatrix} + \frac{A-D}{2} \begin{pmatrix} 1 & 0 \\ 0 & -1 \end{pmatrix}$$

$$= \frac{A+D}{2} \mathbf{1} + B \sigma_B + C \sigma_C + \frac{A-D}{2} \sigma_A$$

$$= \frac{A+D}{2} \sigma_0 + \frac{\Omega_B}{2} \sigma_B + \frac{\Omega_C}{2} \sigma_C + \frac{\Omega_A}{2} \sigma_A$$

$$\vec{\Omega} = \begin{pmatrix} \Omega_A \\ \Omega_B \\ \Omega_C \end{pmatrix} = \begin{pmatrix} A-D \\ 2B \\ 2C \end{pmatrix}$$

From:
QTCA
Lect. 9(2.12)
p. 58

Circular-Coriolis... C-Type motion

$$\begin{pmatrix} \langle 1|\mathbf{H}^C|1\rangle & \langle 1|\mathbf{H}^C|2\rangle \\ \langle 2|\mathbf{H}^C|1\rangle & \langle 2|\mathbf{H}^C|2\rangle \end{pmatrix} = \begin{pmatrix} \Omega_0 & -iC \\ iC & \Omega_0 \end{pmatrix} = \Omega_0 \begin{pmatrix} 1 & 0 \\ 0 & 1 \end{pmatrix} + C \begin{pmatrix} 0 & -i \\ i & 0 \end{pmatrix} = \Omega_0 \sigma_0 + \frac{\Omega_C}{2} \sigma_C$$

$$\text{Crank: } \vec{\Omega} = \begin{pmatrix} \Omega_A \\ \Omega_B \\ \Omega_C \end{pmatrix} = \begin{pmatrix} 0 \\ 0 \\ 2C \end{pmatrix}$$

$$\text{Eigen-Spin: } \vec{S} = \begin{pmatrix} S_A \\ S_B \\ S_C \end{pmatrix} = \begin{pmatrix} 0 \\ 0 \\ \pm S \end{pmatrix}$$

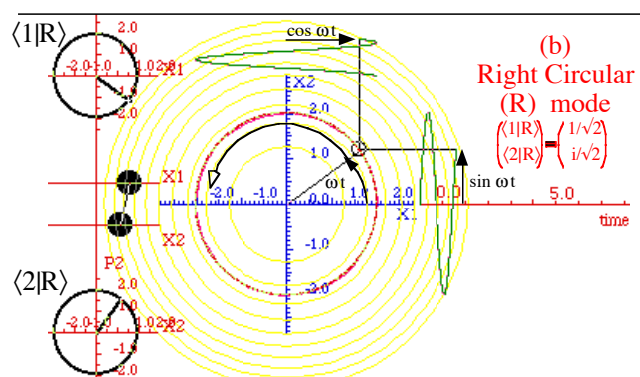
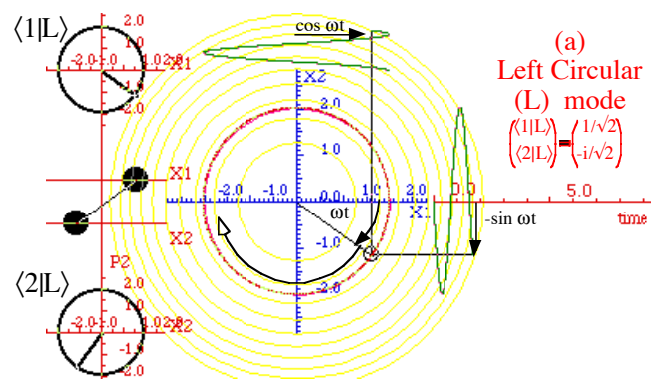
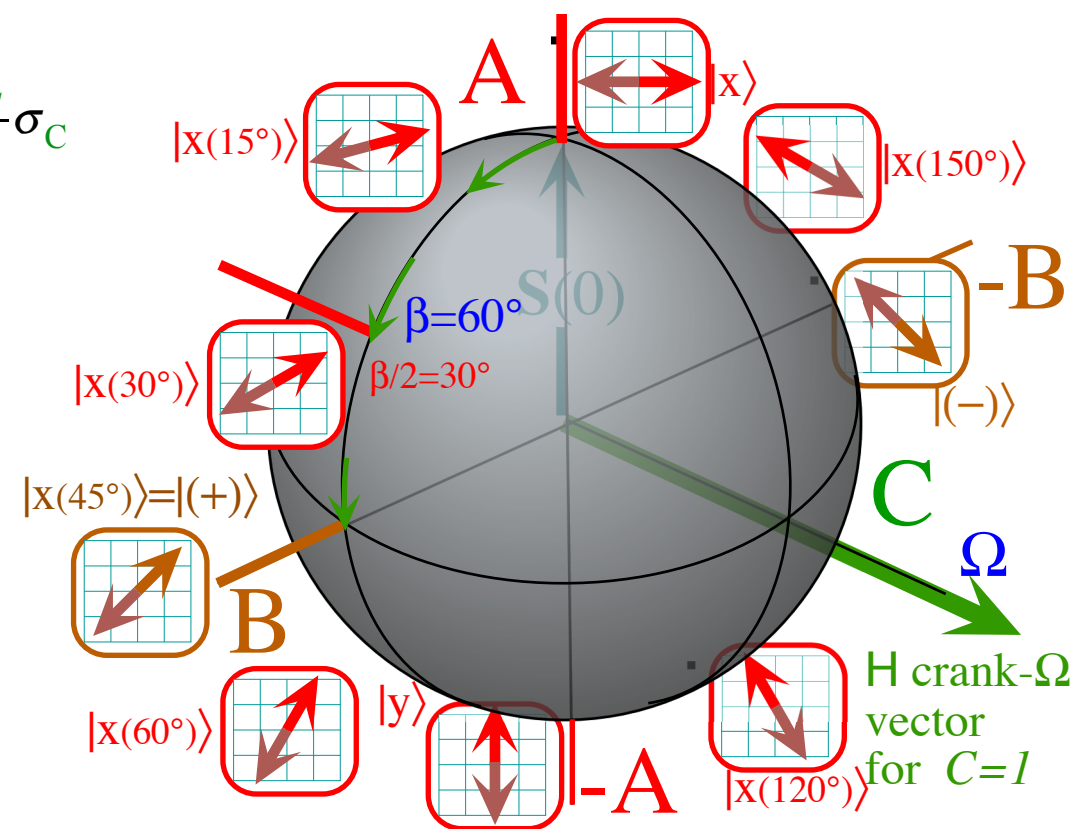

Beat dynamics:

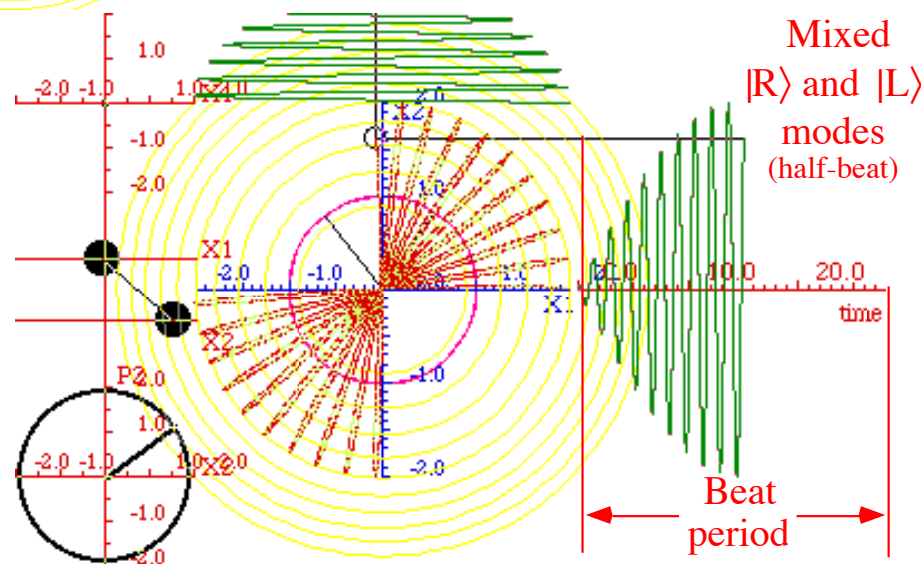
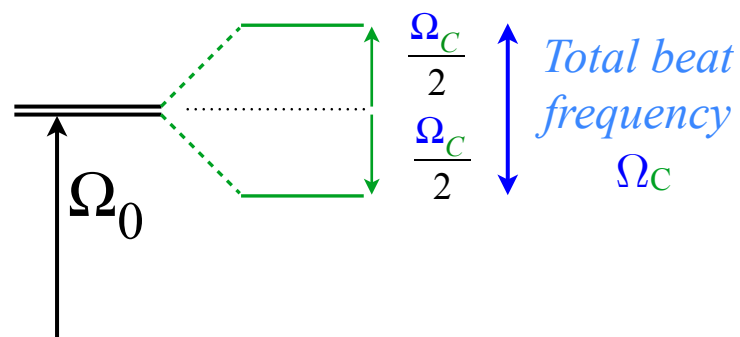

[BoxIt \(C-Type\) Web Simulation](#)

3D-real Stokes Vector defines 2D-HO polarization ellipses and spinor states

Asymmetry $S_A = S_Z$ Balance $S_B = S_X$ and Chirality $S_C = S_Y$

Polarization ellipse and spinor state dynamics

➔ *The “Great Spectral Avoided-Crossing” and A -to- B -to- A symmetry breaking*

The Great Spectral “Avoided-Crossing”

A to B to A Symmetry breaking described by hyperbolic eigenvalues of $A\sigma_A + B\sigma_B = \mathbf{H} = \begin{pmatrix} +A & B \\ B & -A \end{pmatrix}$

$\mathbf{H} = \begin{pmatrix} +A & B \\ B & -A \end{pmatrix}$ Secular equation: $\varepsilon^2 - 0 \cdot \varepsilon - (A^2 + B^2) = 0$ gives *hyperbolic* energy levels: $\varepsilon = \pm\sqrt{A^2 + B^2}$

The Great Spectral "Avoided-Crossing"

A to B to A Symmetry breaking described by hyperbolic eigenvalues of $A\sigma_A + B\sigma_B = \mathbf{H} = \begin{pmatrix} +A & B \\ B & -A \end{pmatrix}$

$\mathbf{H} = \begin{pmatrix} +A & B \\ B & -A \end{pmatrix}$ Secular equation: $\varepsilon^2 - 0 \cdot \varepsilon - (A^2 + B^2)$ gives *hyperbolic* energy levels: $\varepsilon = \pm\sqrt{A^2 + B^2}$

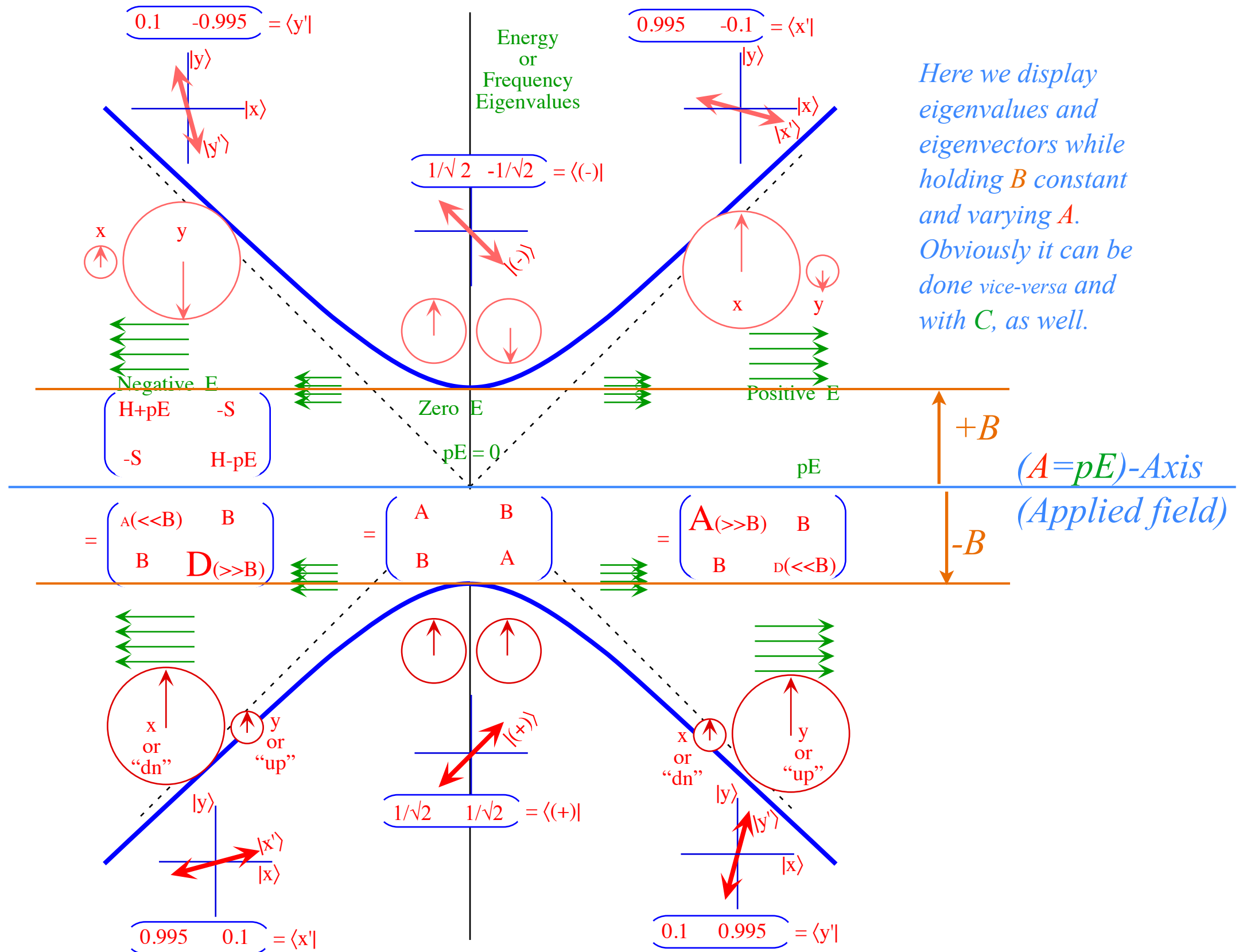

Here we display eigenvalues and eigenvectors while holding B constant and varying A . Obviously it can be done vice-versa and with C , as well.

See also:
QTCA
Lect. 9(2.12)
p.61-66

The Great Spectral "Avoided-Crossing"

A to B to A Symmetry breaking described by hyperbolic eigenvalues of $A\sigma_A + B\sigma_B = \mathbf{H} = \begin{pmatrix} +A & B \\ B & -A \end{pmatrix}$

$\mathbf{H} = \begin{pmatrix} +A & B \\ B & -A \end{pmatrix}$ Secular equation: $\varepsilon^2 - 0 \cdot \varepsilon - (A^2 + B^2)$ gives *hyperbolic* energy levels: $\varepsilon = \pm\sqrt{A^2 + B^2}$

These on-and-off resonance effects are key to:

Laser QCD

Relativistic QED

Quantum computing

Photosynthesis

and a whole lot of other things...

See also:
QTCA
Lect. 9(2.12)
p.61-66

Here we display eigenvalues and eigenvectors while holding B constant and varying A . Obviously it can be done vice-versa and with C , as well.

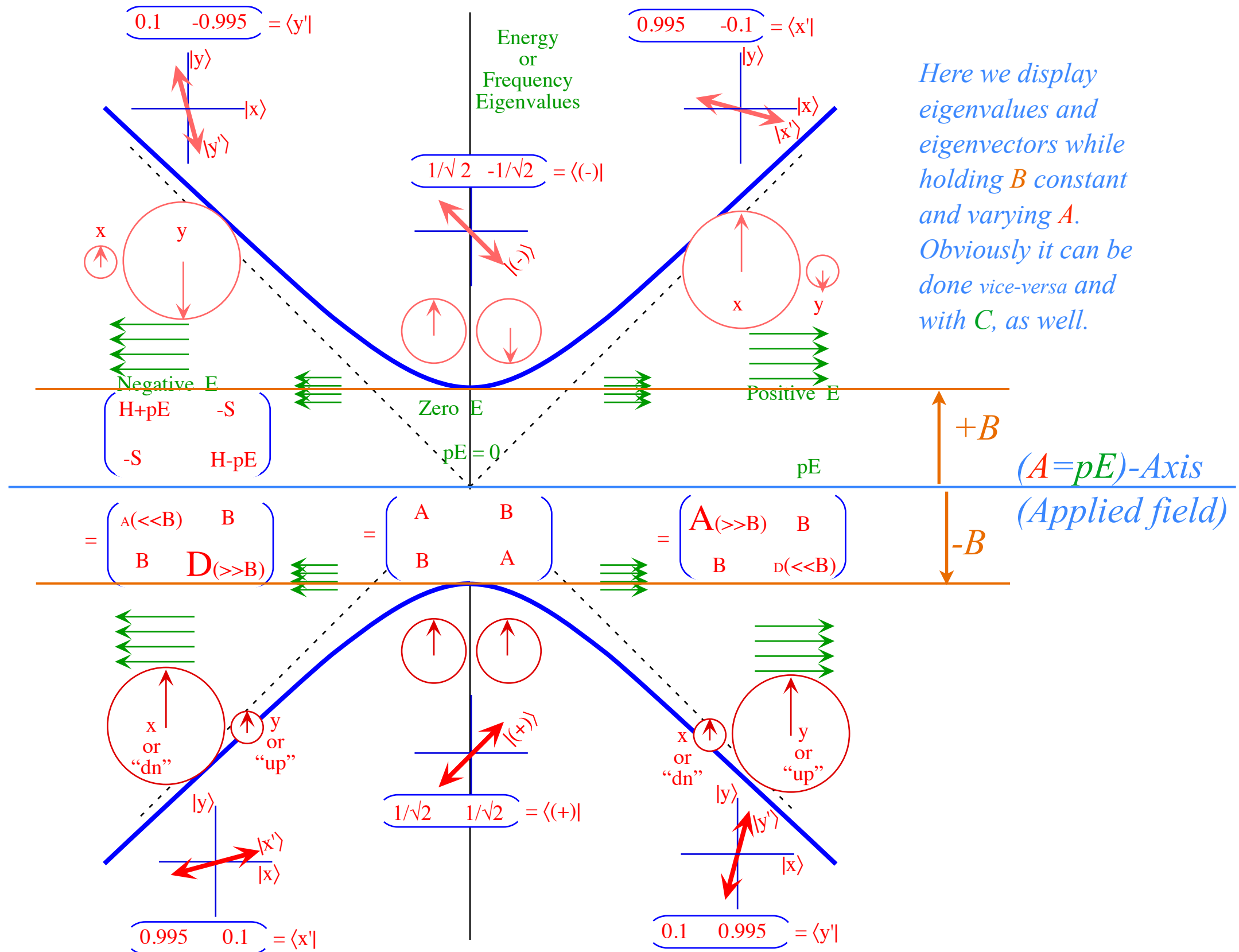

OBJECTIVE: Evaluate and (*most important!*) *visualize* matrix-exponent solutions.

ABCD Time evolution operator

$$|\Psi(t)\rangle = e^{-i\mathbf{H}t}|\Psi(0)\rangle$$

Hamilton generalized Euler's expansion $e^{-i\Omega t} = \cos \Omega t - i \sin \Omega t$ so matrix exponential becomes powerful.

$$e^{-i\mathbf{H}t} = e^{-i \begin{pmatrix} A & B-iC \\ B+iC & D \end{pmatrix} t} = e^{-i \frac{A-D}{2} \begin{pmatrix} 1 & 0 \\ 0 & -1 \end{pmatrix} t - iB \begin{pmatrix} 0 & 1 \\ 1 & 0 \end{pmatrix} t - iC \begin{pmatrix} 0 & -i \\ i & 0 \end{pmatrix} t - i \frac{A+D}{2} \begin{pmatrix} 1 & 0 \\ 0 & 1 \end{pmatrix} t} = e^{-i(\omega_0 \sigma_0 + \vec{\omega} \cdot \vec{\sigma})t} = e^{-i\omega_0 t} (\mathbf{1} \cos \omega t - i \sigma_{\omega} \sin \omega t)$$

$\sigma_A = \sigma_Z$ $\sigma_B = \sigma_X$ $\sigma_C = \sigma_Y$

where: $\vec{\varphi} = \vec{\omega} \cdot t = \begin{pmatrix} \omega_A \\ \omega_B \\ \omega_C \end{pmatrix} \cdot t = \begin{pmatrix} \frac{A-D}{2} \\ B \\ C \end{pmatrix} \cdot t$ and: $\omega_0 = \frac{A+D}{2}$ and: $\vec{\Theta} = \vec{\Omega} \cdot t = \begin{pmatrix} \Omega_A \\ \Omega_B \\ \Omega_C \end{pmatrix} \cdot t = \begin{pmatrix} A-D \\ 2B \\ 2C \end{pmatrix} \cdot t$ and: $\Omega_0 = \frac{A+D}{2}$

Symmetry relations make spinors σ_X , σ_Y , and σ_Z or quaternions $\mathbf{i} = -i\sigma_X$, $\mathbf{j} = -i\sigma_Y$, and $\mathbf{k} = -i\sigma_Z$ powerful.

3D *crank vector* $\vec{\Theta} = \vec{\Omega} \cdot t$ and *spin operator* \mathbf{S} defines 3D *ABC*-rotation with ratio $\frac{1}{2}$ or 2 between Θ_a and $\varphi_a = \frac{1}{2} \Theta_a$ or between \mathbf{S} and $\sigma = 2\mathbf{S}$.

$$e^{-i\sigma \cdot \vec{\varphi}} = e^{-i\sigma \cdot \vec{\Theta}/2} = e^{-i\mathbf{S} \cdot \vec{\Theta}} = \mathbf{1} \cos \frac{\Theta}{2} - i (\sigma \cdot \hat{\Theta}) \sin \frac{\Theta}{2} = \begin{pmatrix} \cos \frac{\Theta}{2} - i \hat{\Theta}_A \sin \frac{\Theta}{2} & (-i \hat{\Theta}_B - \hat{\Theta}_C) \sin \frac{\Theta}{2} \\ (-i \hat{\Theta}_B + \hat{\Theta}_C) \sin \frac{\Theta}{2} & \cos \frac{\Theta}{2} + i \hat{\Theta}_A \sin \frac{\Theta}{2} \end{pmatrix}$$

Example 3:
Any $\vec{\Theta} = \vec{\Omega}t$ -axial rotation

2D angle: $\varphi = \frac{1}{2} \Theta$

3D Crank vector: $\vec{\Theta} = \Theta \hat{\Theta} = 2\varphi_a \hat{a} = 2\vec{\varphi}$

2D spin matrix: $\mathbf{S} = \frac{1}{2} \sigma$

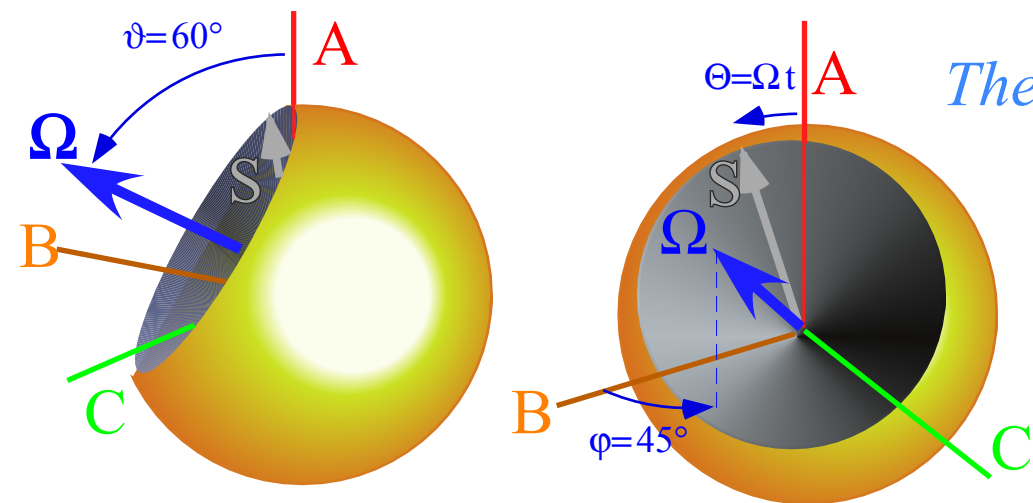

The driving $\vec{\Theta} = \vec{\Omega}t$ vector is defined by the *ABCD* of Hamiltonian \mathbf{H} .

The driven spin vector \mathbf{S} defines the state. But, how?

Fig. 3.4.2 Two views of Hamilton crank vector $\Omega(\varphi, \theta)$ whirling Stokes state vector \mathbf{S} in *ABC*-space.

Euler $R(\alpha\beta\gamma)$ versus Darboux $R[\varphi\vartheta\Theta]$

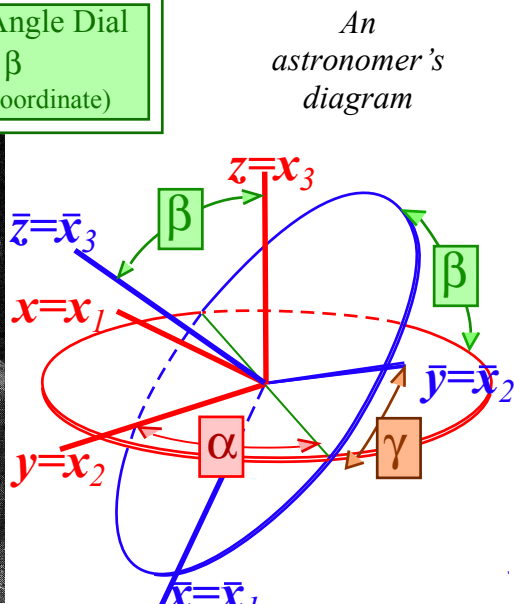
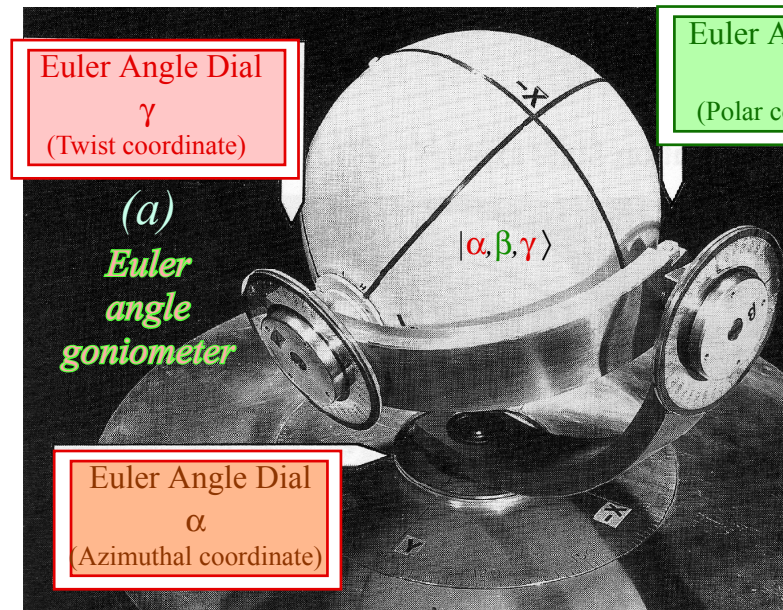

From: QTCA Lect. 9(2.12) (See p.5-23 there)

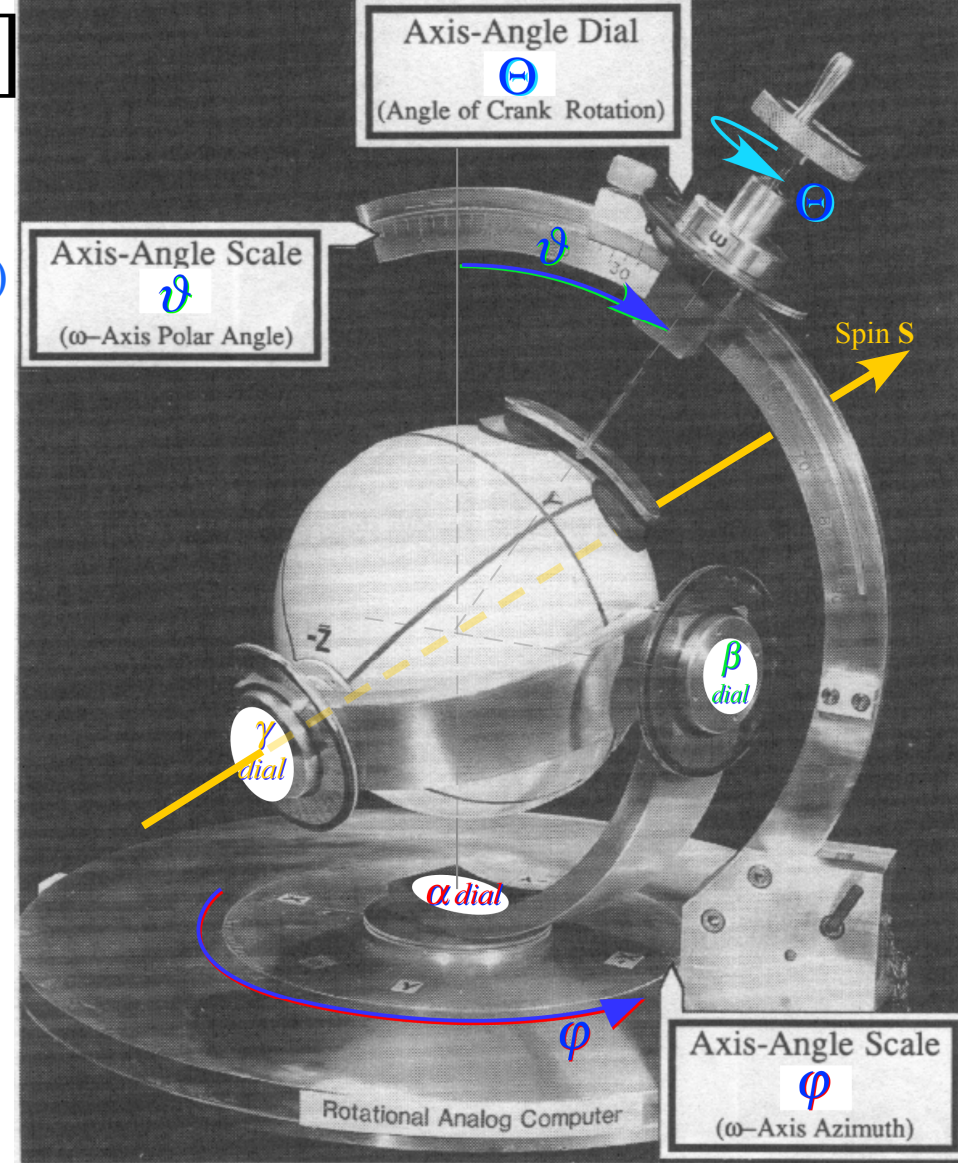

Third rotation $R(\alpha 0 0)$ Second rotation $R(0 \beta 0)$ First rotation $R(0 0 \gamma)$

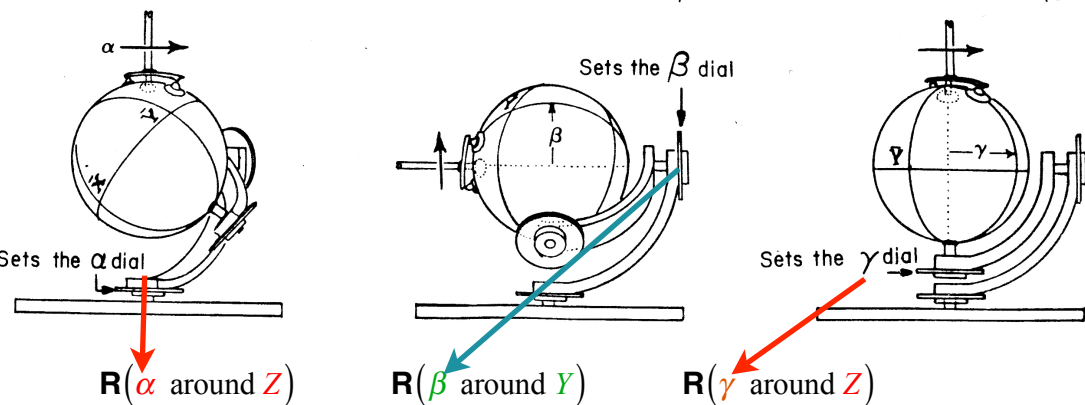

$$R(\alpha\beta\gamma) = \begin{pmatrix} e^{-i\frac{\alpha}{2}} & 0 \\ 0 & e^{i\frac{\alpha}{2}} \end{pmatrix} \begin{pmatrix} \cos\frac{\beta}{2} & -\sin\frac{\beta}{2} \\ \sin\frac{\beta}{2} & \cos\frac{\beta}{2} \end{pmatrix} \begin{pmatrix} e^{-i\frac{\gamma}{2}} & 0 \\ 0 & e^{i\frac{\gamma}{2}} \end{pmatrix} = \begin{pmatrix} e^{-i\frac{\alpha+\gamma}{2}} \cos\frac{\beta}{2} & -e^{-i\frac{\alpha-\gamma}{2}} \sin\frac{\beta}{2} \\ e^{i\frac{\alpha-\gamma}{2}} \sin\frac{\beta}{2} & e^{i\frac{\alpha+\gamma}{2}} \cos\frac{\beta}{2} \end{pmatrix}$$

$$R[\bar{\Theta}] = \begin{pmatrix} \cos\frac{\Theta}{2} - i\hat{\Theta}_Z \sin\frac{\Theta}{2} & -i\sin\frac{\Theta}{2}(\hat{\Theta}_X - i\hat{\Theta}_Y) \\ -i\sin\frac{\Theta}{2}(\hat{\Theta}_X + i\hat{\Theta}_Y) & \cos\frac{\Theta}{2} + i\hat{\Theta}_Z \sin\frac{\Theta}{2} \end{pmatrix} = R[\varphi\vartheta\Theta] = e^{-iHt}$$

$$= \cos\frac{\Theta}{2} \begin{pmatrix} 1 & 0 \\ 0 & 1 \end{pmatrix} - i \begin{pmatrix} 0 & 1 \\ 1 & 0 \end{pmatrix} \hat{\Theta}_X \sin\frac{\Theta}{2} - i \begin{pmatrix} 0 & -i \\ i & 0 \end{pmatrix} \hat{\Theta}_Y \sin\frac{\Theta}{2} - i \begin{pmatrix} 1 & 0 \\ 0 & -1 \end{pmatrix} \hat{\Theta}_Z \sin\frac{\Theta}{2}$$

Euler $R(\alpha\beta\gamma)$ is simpler to form than Θ -axis Darboux $R[\varphi\vartheta\Theta]$.

Euler *state definition* lets us relate $R(\alpha\beta\gamma)$ to $R[\varphi\vartheta\Theta]$...

$$|\alpha\beta\gamma\rangle = R(\alpha\beta\gamma)|000\rangle \quad (\alpha\beta\gamma \text{ make better coordinates})$$

$$\begin{pmatrix} e^{-i\frac{\alpha+\gamma}{2}} \cos\frac{\beta}{2} & -e^{-i\frac{\alpha-\gamma}{2}} \sin\frac{\beta}{2} \\ e^{i\frac{\alpha-\gamma}{2}} \sin\frac{\beta}{2} & e^{i\frac{\alpha+\gamma}{2}} \cos\frac{\beta}{2} \end{pmatrix} \begin{pmatrix} 1 \\ 0 \end{pmatrix} = \begin{pmatrix} x_1 + ip_1 \\ x_2 + ip_2 \end{pmatrix}$$

$$\begin{aligned} x_1 &= \cos[(\gamma+\alpha)/2] \cos\beta/2 = \cos\Theta/2 \\ -p_2 &= \sin[(\gamma-\alpha)/2] \sin\beta/2 = \hat{\Theta}_X \sin\Theta/2 \\ x_2 &= \cos[(\gamma-\alpha)/2] \sin\beta/2 = \hat{\Theta}_Y \sin\Theta/2 \\ -p_1 &= \sin[(\gamma+\alpha)/2] \cos\beta/2 = \hat{\Theta}_Z \sin\Theta/2 \end{aligned}$$

$$= \begin{pmatrix} \cos\frac{\Theta}{2} - i\cos\vartheta \sin\frac{\Theta}{2} & -\sin\frac{\Theta}{2}(\sin\varphi \sin\vartheta + i\cos\varphi \sin\vartheta) \\ \sin\frac{\Theta}{2}(\sin\varphi \sin\vartheta - i\cos\varphi \sin\vartheta) & \cos\frac{\Theta}{2} + i\cos\vartheta \sin\frac{\Theta}{2} \end{pmatrix}$$

$$= \begin{pmatrix} \cos\varphi \sin\vartheta \sin\Theta/2 & \sin\varphi \sin\vartheta \sin\Theta/2 \\ \cos\vartheta \sin\Theta/2 & \cos\vartheta \sin\Theta/2 \end{pmatrix}$$

Ellipsometry using $U(2)$ symmetry coordinates

Conventional amp-phase ellipse coordinates related to Euler Angles $(\alpha\beta\gamma)$

2D elliptic frequency ω orbit has amplitudes A_1 and A_2 , and phase shifts ρ_1 and $\rho_2 = -\rho_1$.

Real x_k and imaginary p_k parts of phasor amplitudes $a_k = x_k + ip_k$ depend on Euler angles $(\alpha\beta\gamma)$ and A .

$$\begin{pmatrix} A_1 e^{-i(\omega t + \rho_1)} \\ A_2 e^{-i(\omega t - \rho_1)} \end{pmatrix} = \begin{pmatrix} x_1 + ip_1 \\ x_2 + ip_2 \end{pmatrix} \begin{matrix} x_1 = A_1 \cos(\omega t + \rho_1) \\ -p_1 = A_1 \sin(\omega t + \rho_1) \\ x_2 = A_2 \cos(\omega t - \rho_1) \\ -p_2 = A_2 \sin(\omega t - \rho_1) \end{matrix}$$

$$\begin{matrix} x_1 = A \cos \beta/2 \cos[(\gamma + \alpha)/2] \\ -p_1 = A \cos \beta/2 \sin[(\gamma + \alpha)/2] \\ x_2 = A \sin \beta/2 \cos[(\gamma - \alpha)/2] \\ -p_2 = A \sin \beta/2 \sin[(\gamma - \alpha)/2] \end{matrix} \begin{pmatrix} A e^{-i\frac{\alpha+\gamma}{2}} \cos \frac{\beta}{2} \\ A e^{i\frac{\alpha-\gamma}{2}} \sin \frac{\beta}{2} \end{pmatrix} = \begin{pmatrix} x_1 + ip_1 \\ x_2 + ip_2 \end{pmatrix}$$

Let: $A_1 = A \cos \beta/2$
 $A_2 = A \sin \beta/2$ Let: $\omega t + \rho_1 = (\gamma + \alpha)/2$
 $\omega t - \rho_1 = (\gamma - \alpha)/2$

$$\tan \beta/2 = A_2/A_1 \quad A^2 = A_1^2 + A_2^2$$

$$\alpha = 2\rho_1 \quad \gamma = 2\omega t$$

Euler parameters $(\alpha, \beta, \gamma, A)$ in terms of amp-phase parameters $(A_1, A_2, \omega t, \rho_1)$

$$\begin{pmatrix} A e^{-i\frac{\alpha+\gamma}{2}} \cos \frac{\beta}{2} \\ A e^{i\frac{\alpha-\gamma}{2}} \sin \frac{\beta}{2} \end{pmatrix} = \begin{pmatrix} A_1 e^{-i(\omega t + \rho_1)} \\ A_2 e^{-i(\omega t - \rho_1)} \end{pmatrix} = \begin{pmatrix} x_1 + ip_1 \\ x_2 + ip_2 \end{pmatrix}$$

See also:
 QTCA
 Lect. 9(2.12)
 See pp. 96-104